



# **CART CATALOG**

*Track Side Race Support, Mobile Workstations, Toolboxes, and MORE*

**WE BUILD IT BETTER**



**CTECH**  
**MANUFACTURING**  
**ALUMINUM CARTS, CABINETS & DRAWERS**

*With a passion for racing, Jim Greenheck, CTech Manufacturing President/ Owner, needed a quality storage solution when on the road with his drag car. Jim sought after his own design and built the first CTech cabinet. He took into consideration "MOBILE APPLICATION" when engineering the first CTech products and that still holds true to this day.*

*CTech was developed to be lighter, stronger, and of a higher quality than anything else available. By concentrating on product innovation and listening to our customers, we have maintained our reputation for being the most respected name in storage products!*

*These innovations have grown our product offerings to include all-aluminum carts, cabinets, drawers and tactical cabinets. These products cover a number of different industries which continue to evolve and grow with each request. Our products have been used in a variety of mobile and stationary applications.*

*CTech stays engaged with customers to deliver new and innovative solutions every day. From major race teams to global energy companies, our people, technology, and engineering practices allow us to continue this trend of innovation.*

## **WE BUILD IT BETTER**

**NO MATTER WHAT INDUSTRY  
WE GUARANTEE A SUPERIOR PRODUCT**



*CTech added 80,000 sq ft to its manufacturing facility in 2018 to better serve current customers and answer an increased demand for new business.*



# TABLE OF CONTENTS



<b>FEATURES:</b>	6-9	<b>72",84" TIMING STAND:</b>	41
<b>SERVICE CARTS:</b>	10-11	<b>104" TIMING STAND:</b>	42-43
<b>CASTER CARTS:</b>	12-15	<b>JR TRANSPORTER:</b>	44
<b>BAD ASS CASTER CARTS:</b>	16-19	<b>TWIN PLATFORM:</b>	45
<b>HOT ROD CARTS:</b>	20-21	<b>TRANSPORTER:</b>	46
<b>MINI CARTS:</b>	22-27	<b>ULTRA CART:</b>	47
<b>WORKTOP CARTS:</b>	28-31	<b>ULTRA CART - DUAL DECK:</b>	48-49
<b>PRO SERIES CARTS:</b>	32-35	<b>OPTIONS:</b>	50-53
<b>GARAGE BOX:</b>	36	<b>CUSTOM CARTS:</b>	
<b>GARAGE BOX NEW STYLE:</b>	37	<b>Racing/Pit Carts:</b>	54-55
<b>72" FUEL CART:</b>	38	<b>Deck Carts:</b>	56-57
<b>84" FUEL CART:</b>	39	<b>Industrial Carts:</b>	58-59
<b>PREMIUM OBSERVATION:</b>	40	<b>INDUSTRIES SERVED:</b>	60-63

CARTS

**ACCESSORIES:** 64-67

**PRODUCT PORTFOLIO:** 68-69

**POLICIES & PROCEDURES:** 70

**CTECH ADVANTAGE:** 71



BLACKLINE





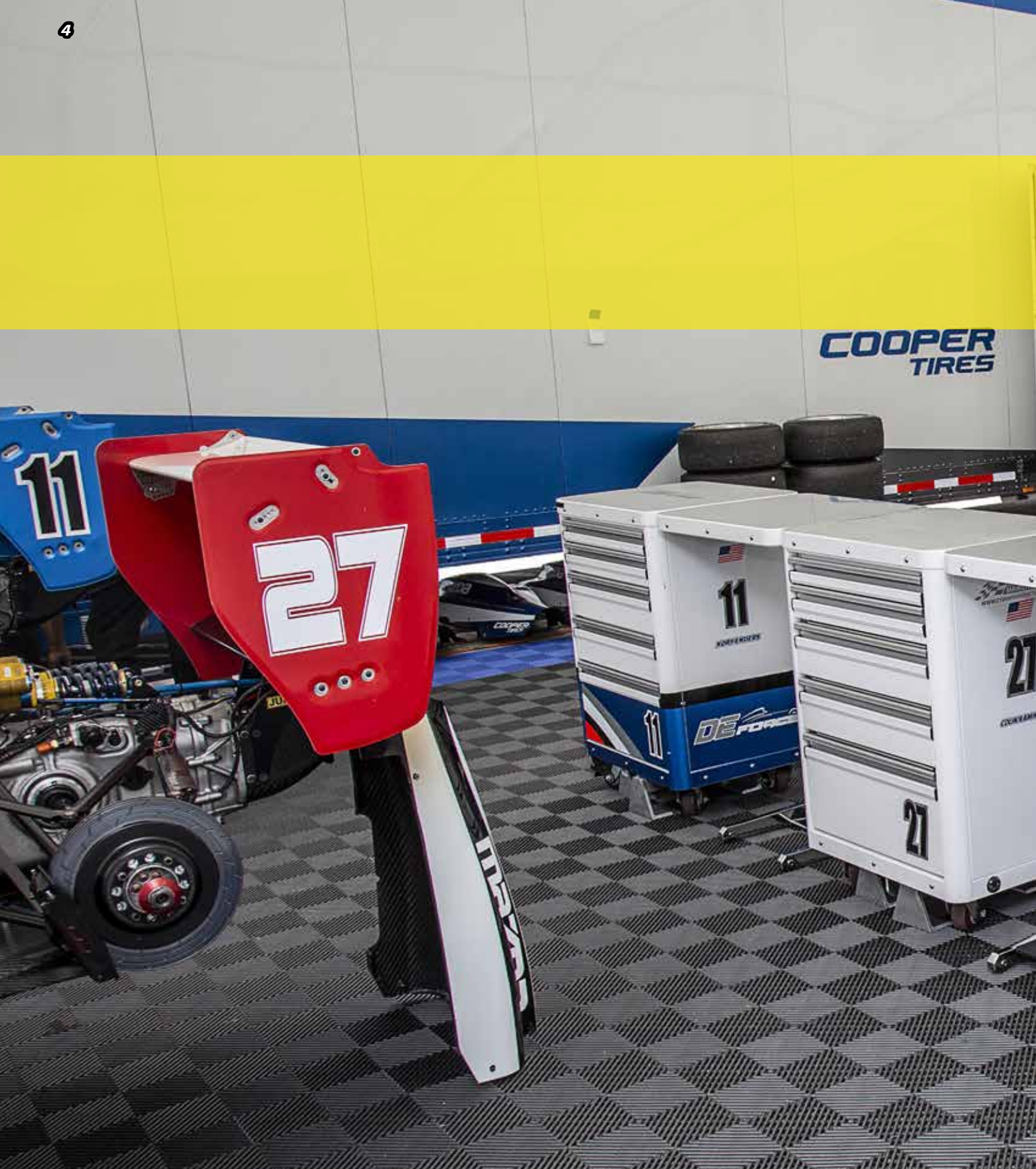

**TOOL STORAGE TO GO!** AT THE TRACK, IN THE TRAILER, OR IN THE SHOP





# CARTS



***ALWAYS ON THE JOB***



**Shown with optional features:**

- Removable Tire Rack
- Race Day Canopy
- Black Anodized Handles

**Adjustable Shelving**

-Storage requirements change from time to time, let your storage solution change with it. Adjust your shelves or add more as needed.

**Radius Corners**

-Radius "snag free" corners set CTech carts apart from our competitors in functionality, construction, and aesthetics.

**Heavy Duty Handle**

-Multiple styles available based on cart.

**MotionLatch™ Doors**

-The ONLY door latch with a full length grab area!

**Built in "D" Rings**

- Optional for each cart style, CTech offers multiple styles of tie down rings for transport.

**Heavy Duty Wheels**

- Heavy Duty Casters, Bad Ass Caster, Flat Free or Pneumatic tire options are available to fit any function.

**MotionLatch™ Drawers**

- "ONE HAND - ONE MOTION" opening function lets you grab anywhere on the extruded aluminum handle and effortlessly open our 250lb rated drawers.



**5052**  
ALUMINUM  
BODY PANELS

EXTRUDED  
ALUMINUM FRAME



**RADIUS  
CORNERS**  
FASTENER ASSEMBLED

FEATURES WITH (\*) CAN BE SEEN IN THE EXPANDED FEATURE DESCRIPTIONS ON THE FOLLOWING PAGES





Engineered with strong aluminum extrusions

## INDUSTRY FIRST!

### MOTIONLATCH™ DRAWERS & DOORS

- Offers “ONE HAND - ONE MOTION” operation even with a handful of tools.
- No pinching, no squeezing, no twisting, just pull the handle and the latches release.
- MotionLatch™ opening function lets you grab anywhere on the extruded aluminum handle and effortlessly open our 250lb rated drawers.

CTECH EXCLUSIVE

**MotionLatch™**

**Drawer & Door System**

US Patent 6,547,289



Dual-composite latches stay closed

**CTECH EXCLUSIVE**  
**2" RADIUS CORNERS**



Radius extrusion corner and extrusion framework



***EXTRUDED RADIUS CORNERS***  
***with FASTENER ASSEMBLY***

- Snag-Free 2" radius corner eliminates sharp edges for a safe and efficient working area.
- All-aluminum extrusion framework provides durable construction at a fraction of the weight.
- Engineered with fastener assembly to withstand harsh mobile applications and challenging terrain.



Mechanically fastened





4" Caster



10" Bad Ass Caster  
- ALL TERRAIN



10" Flat Free Wheel



16" Pneumatic Wheel

**PREMIUM WHEELS  
for PREMIUM CARTS**

- Heavy Duty 4" Rigid Casters with brakes - quality heavy duty casters for quality carts
- Extreme Duty 10" Bad Ass Casters with brakes - designed for all-terrain applications
- Flat Free tires and Billet Aluminum wheels standard with brakes
- Pneumatic tires and Polished wheels - hydraulic disc brakes optional
- Industrial Grade Flat Free tires with steel wheels - Hydraulic disc brakes optional, best performing wheels with heavily-loaded carts



16" Flat Free  
Wheel



# SERVICE CARTS



The versatile service cart or shop cart, is the heavy duty solution for any job. Great for temporary storage of tools, parts and supplies during a task. This handy cart helps eliminates the time associated with walking back and forth to your toolbox or bench. All shelves and drawers are equipped with heavy duty liner. The removable inverted top makes for easy clean up. Available in 12 standard powder coat colors with many customizable add-ons to make one all your own.

4" SWIVEL CASTERS



LOCKED







<b>SPECIFICATIONS:</b>	<b>CC363624A</b>
WIDTH	36"
HEIGHT	36"
DEPTH	24"
LOAD CAPACITY	250 lbs per shelf (750lbs)
DRAWERS	NA
NET WEIGHT	75 lbs
MSRP	\$581.90

## SERVICE CART - CC363624A

- Inverted top (removable)
- Heavy duty casters
- Extruded aluminum frame
- Radius corners - snag free
- (1) Shelf with heavy duty liner

<b>SPECIFICATIONS:</b>	<b>CC363624D</b>
WIDTH	36"
HEIGHT	36"
DEPTH	24"
LOAD CAPACITY	250 lbs per shelf/drawer (1000lbs)
DRAWERS	1- 4"
NET WEIGHT	100 lbs
MSRP	\$713.90

## SERVICE CART - CC363624D

- (1) 4" MotionLatch™ drawer
- Inverted top (removable)
- Heavy duty casters
- Extruded aluminum frame
- Radius corners - snag free
- (1) Shelf with heavy duty liner



## POWDER COAT COLORS:



\* ANY STANDARD PRODUCT CAN BE CUSTOMIZED TO YOUR SPECIFIC NEEDS, PLEASE CALL 715-355-8842 AND TALK TO YOUR CTECH REPRESENTATIVE TODAY. \*



# CASTER CARTS



If you are looking for the most durable caster cart in a 1, 2, or 3 opening configuration, look no further. Our heavy duty casters (2 swivel with brakes, 2 fixed) are ideal for any hard surface and roll with ease even with the heaviest supplies. All MotionLatch™ drawers and shelves are equipped with heavy duty liner and rated for 250lbs. MotionLatch™ doors offer easy access with a secure closure. Available in 10 standard powder coat colors, 12 standard configurations, and many customizable add-ons to make one all your own.

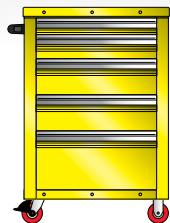

**TYPE 1**

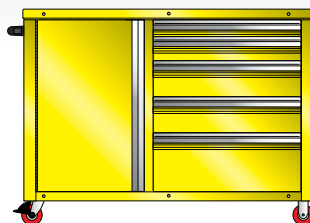

**TYPE 2**

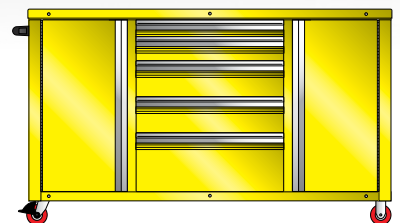

**TYPE 3**



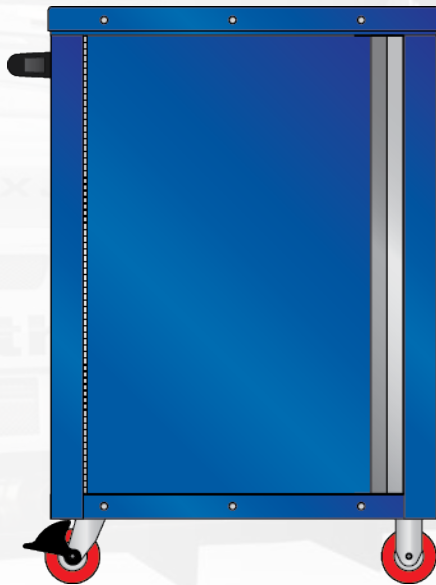

<b>SPECIFICATIONS:</b>	<b>CC244024A</b>
<b>WIDTH</b>	<b>24"</b>
<b>HEIGHT</b>	<b>40"</b>
<b>DEPTH</b>	<b>24"</b>
<b>LOAD CAPACITY</b>	<b>250 lbs per drawer/shelf</b>
<b>DRAWERS</b>	<b>NA</b>
<b>NET WEIGHT</b>	<b>83 lbs</b>
<b>MSRP</b>	<b>\$1,204.50</b>

#### CASTER CART - CC244024A - TYPE 1

- (1) MotionLatch™ door
- Adjust-A-Loc Shelves
- Heavy Duty push/pull handle
- Heavy duty casters
- Extruded aluminum framework
- Radius corners - snag free

<b>SPECIFICATIONS:</b>	<b>CC244024C</b>
<b>WIDTH</b>	<b>24"</b>
<b>HEIGHT</b>	<b>40"</b>
<b>DEPTH</b>	<b>24"</b>
<b>LOAD CAPACITY</b>	<b>250 lbs per drawer</b>
<b>DRAWERS</b>	<b>1-3", 1-4", 2-6", 1-10"</b>
<b>NET WEIGHT</b>	<b>165 lbs</b>
<b>MSRP</b>	<b>\$2,084.50</b>

#### CASTER CART - CC244024C - TYPE 1

- (5) MotionLatch™ drawers  
-250 lbs load rating per drawer + heavy duty liner
- Heavy Duty push/pull handle
- Heavy duty casters
- Extruded aluminum framework
- Radius corners - snag free



<b>SPECIFICATIONS:</b>	<b>CC244024E</b>
<b>WIDTH</b>	<b>24"</b>
<b>HEIGHT</b>	<b>40"</b>
<b>DEPTH</b>	<b>24"</b>
<b>LOAD CAPACITY</b>	<b>250 lbs per drawer/shelf</b>
<b>DRAWERS</b>	<b>1-4"</b>
<b>NET WEIGHT</b>	<b>93 lbs</b>
<b>MSRP</b>	<b>\$1,375.00</b>

#### CASTER CART - CC244024E - TYPE 1

- (1) MotionLatch™ drawer  
-250 lbs load rating per drawer + heavy duty liner
- (1) MotionLatch™ door
- Adjust-A-Loc Shelves
- Heavy Duty push/pull handle
- Heavy duty casters
- Extruded aluminum framework
- Radius corners - snag free

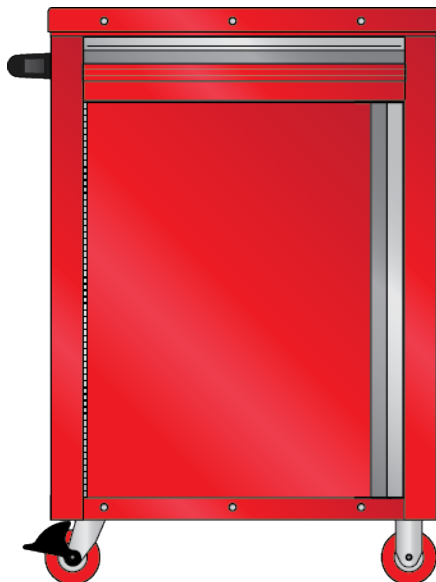

#### POWDER COAT COLORS:



\* ANY STANDARD PRODUCT CAN BE CUSTOMIZED TO YOUR SPECIFIC NEEDS, PLEASE CALL 715-355-8842 AND TALK TO YOUR CTECH REPRESENTATIVE TODAY. \*

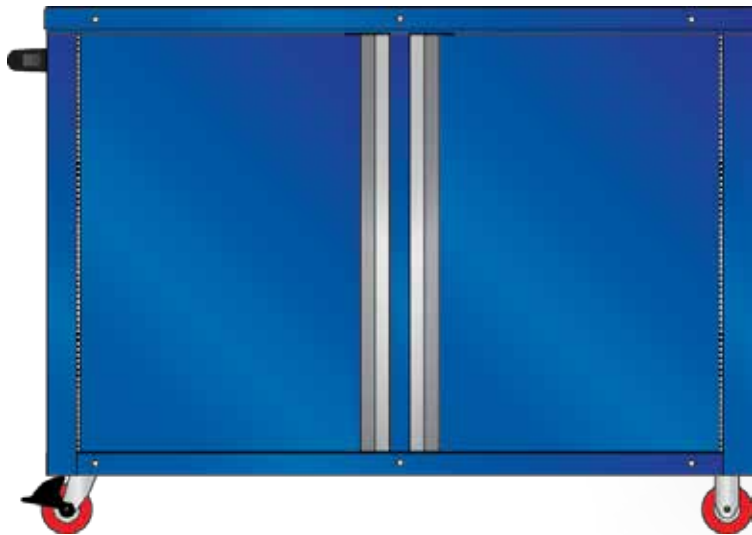

<b>SPECIFICATIONS:</b>	<b>CC484024A</b>
<b>WIDTH</b>	<b>48"</b>
<b>HEIGHT</b>	<b>40"</b>
<b>DEPTH</b>	<b>24"</b>
<b>LOAD CAPACITY</b>	<b>250 lbs per shelf</b>
<b>DRAWERS</b>	<b>NA</b>
<b>NET WEIGHT</b>	<b>126 lbs</b>
<b>MSRP</b>	<b>\$1,703.90</b>

CASTER CART - CC484024A - TYPE 2

- (2) MotionLatch™ door
- Adjust-A-Loc Shelves
- Heavy Duty push/pull handle
- Heavy duty casters
- Extruded aluminum framework
- Radius corners - snag free

<b>SPECIFICATIONS:</b>	<b>CC484024C</b>
<b>WIDTH</b>	<b>48"</b>
<b>HEIGHT</b>	<b>40"</b>
<b>DEPTH</b>	<b>24"</b>
<b>LOAD CAPACITY</b>	<b>250 lbs per shelf</b>
<b>DRAWERS</b>	<b>1-3", 1-4", 2-6" and 1-10"</b>
<b>NET WEIGHT</b>	<b>200 lbs</b>
<b>MSRP</b>	<b>\$2,704.90</b>

CASTER CART - CC484024C - TYPE 2

- (5) MotionLatch™ drawers  
-250 lbs load rating per drawer + heavy duty liner
- (1) MotionLatch™ door
- Adjust-A-Loc Shelves
- Heavy Duty push/pull handle
- Heavy duty casters
- Extruded aluminum framework
- Radius corners - snag free



<b>SPECIFICATIONS:</b>	<b>CC484024E</b>
<b>WIDTH</b>	<b>48"</b>
<b>HEIGHT</b>	<b>40"</b>
<b>DEPTH</b>	<b>24"</b>
<b>LOAD CAPACITY</b>	<b>250 lbs per shelf</b>
<b>DRAWERS</b>	<b>2-4"</b>
<b>NET WEIGHT</b>	<b>157 lbs</b>
<b>MSRP</b>	<b>\$2,062.50</b>

CASTER CART - CC484024E- TYPE 2

- (2) MotionLatch™ drawers  
-250 lbs load rating per drawer + heavy duty liner
- (2) MotionLatch™ door
- Adjust-A-Loc Shelves
- Heavy Duty push/pull handle
- Heavy duty casters
- Extruded aluminum framework
- Radius corners - snag free

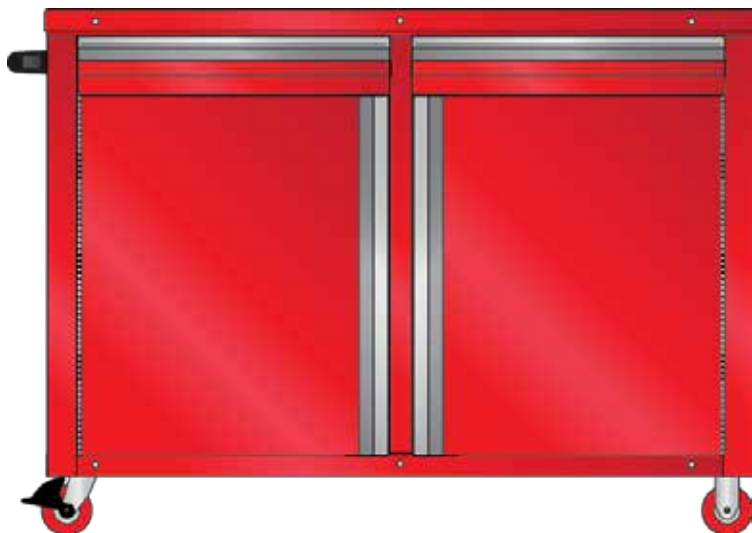

**POWDER COAT COLORS:**



\* ANY STANDARD PRODUCT CAN BE CUSTOMIZED TO YOUR SPECIFIC NEEDS, PLEASE CALL 715-355-8842 AND TALK TO YOUR CTECH REPRESENTATIVE TODAY. \*





SPECIFICATIONS:	CC604024A	CC724024A
WIDTH	60"	72"
HEIGHT	40"	40"
DEPTH	24"	24"
LOAD CAPACITY	250 lbs per shelf	250 lbs per shelf
DRAWERS	NA	NA
NET WEIGHT	154 lbs	169 lbs
MSRP	\$2,084.50	\$2,264.90

CASTER CART - TYPE 3

- (3) MotionLatch™ door
- Adjust-A-Loc Shelves
- Heavy Duty push/pull handle
- Heavy duty casters
- Extruded aluminum framework
- Radius corners - snag free



SPECIFICATIONS:	CC604024C	CC724024C
WIDTH	60"	72"
HEIGHT	40"	40"
DEPTH	24"	24"
LOAD CAPACITY	250 lbs per shelf	250 lbs per shelf
DRAWERS	1-3", 1-4", 2-6" and 1-10"	1-3", 1-4", 2-6" and 1-10"
NET WEIGHT	248 lbs	262 lbs
MSRP	\$2,915.00	\$3,019.50

CASTER CART - TYPE 3

- (5) MotionLatch™ drawers  
-250 lbs load rating per drawer + heavy duty liner
- (2) MotionLatch™ door
- Adjust-A-Loc Shelves
- Heavy Duty push/pull handle
- Heavy duty casters
- Extruded aluminum framework
- Radius corners - snag free



SPECIFICATIONS:	CC604024E	CC724024E
WIDTH	60"	72"
HEIGHT	40"	40"
DEPTH	24"	24"
LOAD CAPACITY	250 lbs per shelf	250 lbs per shelf
DRAWERS	3-4"	3-4"
NET WEIGHT	201 lbs	213 lbs
MSRP	\$2,585.00	\$2,744.50

CASTER CART - TYPE 3

- (3) MotionLatch™ drawers  
-250 lbs load rating per drawer + heavy duty liner
- (3) MotionLatch™ door
- Adjust-A-Loc Shelves
- Heavy Duty push/pull handle
- Heavy duty casters
- Extruded aluminum framework
- Radius corners - snag free



POWDER COAT COLORS:



\* ANY STANDARD PRODUCT CAN BE CUSTOMIZED TO YOUR SPECIFIC NEEDS, PLEASE CALL 715-355-8842 AND TALK TO YOUR CTECH REPRESENTATIVE TODAY. \*



# BAD ASS CASTER CARTS

## -THE LEADING ALL TERRAIN CASTER

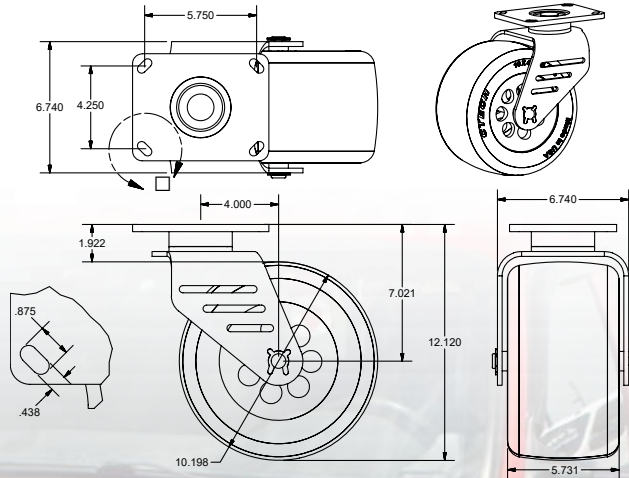

The 10" Bad Ass Caster allows for easy maneuverability over all terrains. Designed to roll like a pneumatic tire while maintaining the load capacities of a caster. These carts are designed for extreme conditions for a caster application and outfitted with 2 swivels with brakes and 2 fixed casters on all standard carts.







<b>SPECIFICATIONS:</b>	<b>BA464830A</b>
<b>WIDTH</b>	<b>48"</b>
<b>HEIGHT</b>	<b>48.5"</b>
<b>DEPTH</b>	<b>30"</b>
<b>LOAD CAPACITY</b>	<b>250 lbs per drawer/shelf</b>
<b>DRAWERS</b>	<b>2-3", 2-4" 1-5", 3-6", 1-8", 1-9", 1-10"</b>
<b>NET WEIGHT</b>	<b>466 lbs</b>
<b>MSRP</b>	<b>\$6,374.50</b>

- BAD ASS MECHANIC CART - BA464830A**
- (11) MotionLatch™ drawers  
-250 lbs load rating per drawer + heavy duty liner
  - Locking drawers
  - Heavy Duty push/pull handle
  - 10" all terrain Bad Ass Casters  
-2 swivel with brakes, 2 fixed
  - Flip top storage
  - Extruded aluminum frame work
  - Radius corners - snag free
  - Two-toned powder coat optional (pictured)

# NEVER BE LIMITED TO THE SHOP FLOOR AGAIN!

<b>SPECIFICATIONS:</b>	<b>BA564830B</b>
<b>WIDTH</b>	<b>56"</b>
<b>HEIGHT</b>	<b>48"</b>
<b>DEPTH</b>	<b>30"</b>
<b>LOAD CAPACITY</b>	<b>250 lbs per drawer/shelf</b>
<b>DRAWERS</b>	<b>4-4", 1-5", 3-6", 1-10"</b>
<b>NET WEIGHT</b>	<b>500 lbs</b>
<b>MSRP</b>	<b>\$8,163.50</b>

- BAD ASS MECHANIC CART - BA564830B**
- (9) MotionLatch™ drawers  
-250 lbs load rating per drawer  
-heavy duty liner
  - (2) full width MotionLatch™ top drawers
  - Locking Drawers
  - Heavy Duty push/pull handle
  - 10" all terrain Bad Ass Casters, 2 swivel with Brakes, 2 fixed
  - Built in D-Rings
  - Flip Lid Top with Inverted Storage Tray
  - Two-toned powder coat optional (pictured)



#### POWDER COAT COLORS:



\* ANY STANDARD PRODUCT CAN BE CUSTOMIZED TO YOUR SPECIFIC NEEDS, PLEASE CALL 715-355-8842 AND TALK TO YOUR CTECH REPRESENTATIVE TODAY. \*



SPECIFICATIONS:	BA-GRILL
WIDTH	48"
HEIGHT	37"- (Cart) 49"- (with grill)
DEPTH	30.5"
LOAD CAPACITY	250 lbs per drawer/shelf
DRAWERS	1-5", 1/8"
NET WEIGHT	357 lbs
MSRP	\$4,394.50

#### GRILL CART - BA-GRILL

- (2) MotionLatch™ drawers
  - 250 lbs load rating per drawer
  - heavy duty liner
- (3) MotionLatch™ door
- Adjust-A-Loc Shelves
- Propane Tank Storage (1 tank and 1 fire extinguisher)
- Vented Rear Panel
- Stainless Steel Top
- Heavy Duty push/pull handle
- 10" All Terrain bad ass casters, 2 swivel with Brakes, 2 fixed
- Bull Grill (designed to fit any standard 24" grill)



#### POWDER COAT COLORS:



\* ANY STANDARD PRODUCT CAN BE CUSTOMIZED TO YOUR SPECIFIC NEEDS, PLEASE CALL 715-355-8842 AND TALK TO YOUR CTECH REPRESENTATIVE TODAY. \*





<b>SPECIFICATIONS:</b>	<b>GEN5636A</b>
WIDTH	56"
HEIGHT	36"
DEPTH	30"
LOAD CAPACITY	250 lbs per drawer/shelf
DRAWERS	NA
NET WEIGHT	615 lbs
MSRP 5.5kw	\$9,179.50 (GEN5636A55)
MSRP 7.0kw	\$10,302.60 (GEN5636A7)

GEN SET CART

- (4) MotionLatch™ doors
- Remote Start/Stop Panel
- (4) 110V outlets, (1) 240V outlet (NEMA 4-30R)
- Vented Floor and Rear Panel
- Heavy Duty push/pull handle
- 10" all terrain Bad Ass Casters, 2 swivel with Brakes, 2 fixed
- Built in D-Rings
- Available in 5.5kW or 7.0kW
- 5.5kw Generator (operates at 67 dB) - Cummins Onan (4 cycle, OHV 90° V-Twin)
- 7kw Generator (operates at 67 dB) - Cummins Onan (4 cycle, OHV 90° V-Twin)

<b>SPECIFICATIONS:</b>	<b>GEN5649B</b>
WIDTH	56"
HEIGHT	48"
DEPTH	30"
LOAD CAPACITY	250 lbs per drawer/shelf
DRAWERS	2-3", 1-5"
NET WEIGHT	700 lbs
MSRP 5.5kw	\$10,851.50 (GEN5649B55)
MSRP 7.0kw	\$11,974.60 (GEN5649B7)

GEN SET CART - STORAGE

- (3) MotionLatch™ drawers  
-250 lbs load rating per drawer  
-heavy duty liner
- (7) MotionLatch™ doors
- Remote Start/Stop Panel
- (7) 110V outlets
- (2) 240V outlet (NEMA 4-30R)
- Vented Floor and Rear Panel
- Heavy Duty push/pull handle
- 10" all terrain Bad Ass Casters, 2 swivel with Brakes, 2 fixed
- Flip Lid Top with Inverted Storage Tray
- 10" All Terrain bad ass casters, 2 swivel with Brakes, 2 fixed
- Built in D-Rings
- 5.5kW Generator (operates at 67 dB) - Cummins Onan (4 cycle, OHV 90° V-Twin)
- 7kW Generator (operates at 67 dB) - Cummins Onan (4 cycle, OHV 90° V-Twin)



**POWDER COAT COLORS:**



\* ANY STANDARD PRODUCT CAN BE CUSTOMIZED TO YOUR SPECIFIC NEEDS, PLEASE CALL 715-355-8842 AND TALK TO YOUR CTECH REPRESENTATIVE TODAY. \*





# HOT ROD CARTS

Featuring the same Flat Free wheels with brakes as the Mini Cart CTech's Hot Rod Chassis gives a nostalgic feel with the addition of wrap around fenders and added effects to the chassis. Each one of the Hot Rod Carts has a special aspect to its design to set it apart from others. All MotionLatch™ drawers and shelves are equipped with heavy duty liner and rated for 250lbs. MotionLatch™ doors offers easy acces. Available in 12 standard powder coat colors.



## THE NAME SAYS IT ALL







SPECIFICATIONS:	HR-WAGON
WIDTH	26"
HEIGHT	14"
DEPTH	40"
LOAD CAPACITY	500 lbs
DRAWERS	NA
NET WEIGHT	75 lbs
MSRP	\$1,094.50

## HOT ROD CART - HR-WAGON

- Heavy Duty push/pull/steering T-handle
- 10" Flat Free Tires with Brakes

SPECIFICATIONS:	HR-FAN
WIDTH	46"
HEIGHT	44.875"
DEPTH	28.125"
LOAD CAPACITY	NA
DRAWERS	NA
NET WEIGHT	110 lbs
MSRP	\$1,864.50

## HOT ROD CART - HR-FAN

- Heavy Duty push/pull/steering T-handle
- 10" Flat Free Tires with Brakes
- Operates at 76 dB
- 1/2hp 2-stage motor
- Cubic ft per minute: 8180 or 18.52 MPR



SPECIFICATIONS:	HR-BD
WIDTH	36.5"
HEIGHT	52"
DEPTH	26"
LOAD CAPACITY	250 lbs per drawer/shelf
DRAWERS	2-3", 1-4", 1-8"
NET WEIGHT	261 lbs
MSRP	\$4,394.50

## BEST DAMN TOOLBOX - HR-BD

- (4) MotionLatch™ drawers  
-250 lbs load rating per drawer + heavy duty liner
- Heavy Duty push/pull/steering T-handle
- 10" Flat Free Tires with Brakes
- Built-in Mac's Tie-Down™ buttons
- Paper towel holder
- Oil can rack
- Zip tie holder
- Peg board surround
- Projack / EZ lift rack



## POWDER COAT COLORS:



\* ANY STANDARD PRODUCT CAN BE CUSTOMIZED TO YOUR SPECIFIC NEEDS, PLEASE CALL 715-355-8842 AND TALK TO YOUR CTECH REPRESENTATIVE TODAY. \*



# MINI CARTS



The Mini Cart chassis features Flat Free wheels with brakes. The one-sided nature of the mini cart design allows for ultimate storage in tight quarters. The chassis also allows for alternate storage possibilities through the series. All MotionLatch™ drawers and shelves are equipped with heavy duty liners and rated for 250lbs. MotionLatch™ doors offer easy access with a secure closure latched every time. Available in 12 standard powder coat colors, 6 standard configurations, and many customizable add-ons to make one all your own.





<b>SPECIFICATIONS:</b>	<b>MC403826A</b>
<b>WIDTH</b>	<b>40"</b>
<b>HEIGHT</b>	<b>38"</b>
<b>DEPTH</b>	<b>26"</b>
<b>LOAD CAPACITY</b>	<b>250 lbs per drawer/shelf</b>
<b>DRAWERS</b>	<b>NA</b>
<b>NET WEIGHT</b>	<b>223 lbs</b>
<b>MSRP</b>	<b>\$2,805.00</b>

#### MINI CART - MC403826A

- (2) MotionLatch™ doors
- Adjust-A-Loc Shelves
- Heavy Duty push/pull/steering T-handle
- 10" Flat Free Tires with Brakes
- Built in D-Rings

<b>SPECIFICATIONS:</b>	<b>MC403826B</b>
<b>WIDTH</b>	<b>40"</b>
<b>HEIGHT</b>	<b>38"</b>
<b>DEPTH</b>	<b>26"</b>
<b>LOAD CAPACITY</b>	<b>250 lbs per drawer/shelf</b>
<b>DRAWERS</b>	<b>2-3", 2-4", 1-6"</b>
<b>NET WEIGHT</b>	<b>341 lbs</b>
<b>MSRP</b>	<b>\$3,874.20</b>

#### MINI CART - MC403826B

- (5) MotionLatch™ drawers  
-250 lbs load rating per drawer + heavy duty liner
- Heavy Duty push/pull/steering T-handle
- Flip Lid Top with Inverted Storage Tray
- 10" Flat Free Tires with Brakes
- Built in D-Rings



<b>SPECIFICATIONS:</b>	<b>MC403826C</b>
<b>WIDTH</b>	<b>40"</b>
<b>HEIGHT</b>	<b>38"</b>
<b>DEPTH</b>	<b>26"</b>
<b>LOAD CAPACITY</b>	<b>250 lbs per drawer/shelf</b>
<b>DRAWERS</b>	<b>2-3", 2-4", 1-6"</b>
<b>NET WEIGHT</b>	<b>309 lbs</b>
<b>MSRP</b>	<b>\$3,404.50</b>

#### MINI CART - MC403826C

- (5) MotionLatch™ drawers  
-250 lbs load rating per drawer  
-heavy duty liner
- (1) MotionLatch™ doors
- Adjust-A-Loc Shelves
- Heavy Duty push/pull/steering T-handle
- 10" Flat Free Tires with Brakes
- Built in D-Rings



#### POWDER COAT COLORS:



\* ANY STANDARD PRODUCT CAN BE CUSTOMIZED TO YOUR SPECIFIC NEEDS, PLEASE CALL 715-355-8842 AND TALK TO YOUR CTECH REPRESENTATIVE TODAY. \*



SPECIFICATIONS:	MC403826D
WIDTH	40"
HEIGHT	38"
DEPTH	26"
LOAD CAPACITY	250 lbs per drawer/shelf
DRAWERS	2-3", 2-4", 1-6"
NET WEIGHT	324 lbs
MSRP	\$3,679.50

#### MINI CART - MC403826D

- (5) MotionLatch™ drawers  
-250 lbs load rating per drawer
- -heavy duty liner
- (1) MotionLatch™ doors
- Adjust-A-Loc Shelves
- Flip Lid Top with Inverted Storage Tray
- Heavy Duty push/pull/steering T-handle
- 10" Flat Free Tires with Brakes
- Built in D-Rings



#### POWDER COAT COLORS:

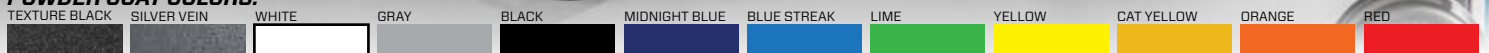

\* ANY STANDARD PRODUCT CAN BE CUSTOMIZED TO YOUR SPECIFIC NEEDS, PLEASE CALL 715-355-8842 AND TALK TO YOUR CTECH REPRESENTATIVE TODAY. \*





<b>SPECIFICATIONS:</b>	<b>MC403826E</b>
<b>WIDTH</b>	<b>40"</b>
<b>HEIGHT</b>	<b>38"</b>
<b>DEPTH</b>	<b>26"</b>
<b>LOAD CAPACITY</b>	<b>250 lbs per drawer/shelf</b>
<b>DRAWERS</b>	<b>1-4"</b>
<b>NET WEIGHT</b>	<b>245 lbs</b>
<b>MSRP</b>	<b>\$3,025.00</b>

#### MINI CART - MC403826E

- (1) MotionLatch™ drawers  
-250 lbs load rating per drawer  
-heavy duty liner
- (1) MotionLatch™ doors
- Adjust-A-Loc Shelves
- Heavy Duty push/pull/steering T-handle
- 10" Flat Free Tires with Brakes
- Built in D-Rings

<b>SPECIFICATIONS:</b>	<b>MC403826F</b>
<b>WIDTH</b>	<b>40"</b>
<b>HEIGHT</b>	<b>38"</b>
<b>DEPTH</b>	<b>26"</b>
<b>LOAD CAPACITY</b>	<b>250 lbs per drawer/shelf</b>
<b>DRAWERS</b>	<b>1-4"</b>
<b>NET WEIGHT</b>	<b>258 lbs</b>
<b>MSRP</b>	<b>\$3,300.00</b>

#### MINI CART - MC403826F

- (1) MotionLatch™ drawers  
-250 lbs load rating per drawer  
-heavy duty liner
- (1) MotionLatch™ doors
- Adjust-A-Loc Shelves
- Flip Lid Top with Inverted Storage Tray
- Heavy Duty push/pull/steering T-handle
- 10" Flat Free Tires with Brakes
- Built in D-Rings



#### POWDER COAT COLORS:



\* ANY STANDARD PRODUCT CAN BE CUSTOMIZED TO YOUR SPECIFIC NEEDS, PLEASE CALL 715-355-8842 AND TALK TO YOUR CTECH REPRESENTATIVE TODAY. \*



<b>SPECIFICATIONS:</b>	<b>MC673826A</b>
<b>WIDTH</b>	<b>67"</b>
<b>HEIGHT</b>	<b>38"</b>
<b>DEPTH</b>	<b>26"</b>
<b>LOAD CAPACITY</b>	<b>250 lbs per drawer/shelf</b>
<b>DRAWERS</b>	<b>2-3", 2-4", 1-6"</b>
<b>NET WEIGHT</b>	<b>388 lbs</b>
<b>MSRP</b>	<b>\$4,834.50</b>

**MINI CART - MC673826A**

- (5) MotionLatch™ drawers  
-250 lbs load rating per drawer  
-heavy duty liner
- (2) MotionLatch™ doors  
Adjust-A-Loc Shelves
- Heavy Duty push/pull/steering T-handle
- 10" Flat Free Tires with Brakes
- Built in D-Rings
- Chassis storage
- Nitrogen Bottle Cradle (chassis)



**NITROGEN STORAGE**

<b>SPECIFICATIONS:</b>	<b>MC673826B</b>
<b>WIDTH</b>	<b>67"</b>
<b>HEIGHT</b>	<b>38"</b>
<b>DEPTH</b>	<b>26"</b>
<b>LOAD CAPACITY</b>	<b>250 lbs per drawer/shelf</b>
<b>DRAWERS</b>	<b>2-3", 2-4", 1-6" X2</b>
<b>NET WEIGHT</b>	<b>497 lbs</b>
<b>MSRP</b>	<b>\$5,428.50</b>

**MINI CART - MC673826B**

- (10) MotionLatch™ drawers  
-250 lbs load rating per drawer  
-heavy duty liner
- Heavy Duty push/pull/steering T-handle
- 10" Flat Free Tires with Brakes
- Built in D-Rings
- Chassis storage
- Nitrogen Bottle Cradle (chassis)



**POWDER COAT COLORS:**



\* ANY STANDARD PRODUCT CAN BE CUSTOMIZED TO YOUR SPECIFIC NEEDS, PLEASE CALL 715-355-8842 AND TALK TO YOUR CTECH REPRESENTATIVE TODAY. \*





SPECIFICATIONS:	MC-GRILL
WIDTH	67"
HEIGHT	38"
DEPTH	26"
LOAD CAPACITY	250 lbs per drawer/shelf
DRAWERS	2-3", 2-4", 1-6"
NET WEIGHT	402 lbs
MSRP	\$6,594.50

## MINI CART - MC-GRILL

- (4) MotionLatch™ drawers  
-250 lbs load rating per drawer  
-heavy duty liner
- (2) MotionLatch™ doors
- Adjust-A-Loc Shelves
- Propane Tank Storage (1 tank and 1 fire extinguisher)
- Vented Rear Door
- Stainless Steel Top
- Flat Free Tires with Brakes
- Bull Grill (designed to fit any standard 24" grill)
- Heavy Duty push/pull/steering T-handle
- 10" Flat Free Tires with Brakes
- Built in D-Rings



## POWDER COAT COLORS:



\* ANY STANDARD PRODUCT CAN BE CUSTOMIZED TO YOUR SPECIFIC NEEDS, PLEASE CALL 715-355-8842 AND TALK TO YOUR CTECH REPRESENTATIVE TODAY. \*



# WORKTOP CARTS

The Work Top Cart is a 360° working experience with **DUAL SIDED** storage as well as chassis storage. The nature of the chassis allows for all types of add-on accessories lending this cart to be one of our most popular across many industries. All MotionLatch™ drawers and shelves are equipped with heavy duty liners and rated for 250lbs. MotionLatch™ doors offers easy access with a secure closure latched every time. Available in 12 standard powder coat colors.







<b>SPECIFICATIONS:</b>	<b>PC604236J</b>
<b>WIDTH</b>	<b>60"</b>
<b>HEIGHT</b>	<b>42"</b>
<b>DEPTH</b>	<b>36"</b>
<b>LOAD CAPACITY</b>	<b>250 lbs per drawer/shelf</b>
<b>DRAWERS</b>	<b>NA</b>
<b>NET WEIGHT</b>	<b>391 lbs</b>
<b>MSRP</b>	<b>\$4,757.50</b>

**WORK TOP CART - PC604236J**

- (6) MotionLatch™ doors
- (3) MotionLatch™ doors (chassis)
- Adjust-A-Loc Shelves
- Dual-sided storage
- Heavy Duty push/pull/steering T-handle
- 16" Pneumatic Tires - Optional Hydraulic Brakes
- Built in D-Rings



REVERSE SIDE



<b>SPECIFICATIONS:</b>	<b>PC604236K</b>
<b>WIDTH</b>	<b>60"</b>
<b>HEIGHT</b>	<b>42"</b>
<b>DEPTH</b>	<b>36"</b>
<b>LOAD CAPACITY</b>	<b>250 lbs per drawer/shelf</b>
<b>DRAWERS</b>	<b>2-3", 3-4", 2-6"</b>
<b>NET WEIGHT</b>	<b>514 lbs</b>
<b>MSRP</b>	<b>\$5,494.50</b>

**WORK TOP CART - PC604236K**

- (7) MotionLatch™ drawers  
-250 lbs load rating per drawer  
-heavy duty liner
- (5) MotionLatch™ doors
- Adjust-A-Loc Shelves
- (2) MotionLatch™ doors (chassis)
- Dual-sided storage
- Heavy Duty push/pull/steering T-handle
- 16" Pneumatic Tires
- Optional Hydraulic Brakes
- Built in D-Rings



REVERSE SIDE

**POWDER COAT COLORS:**



\* ANY STANDARD PRODUCT CAN BE CUSTOMIZED TO YOUR SPECIFIC NEEDS, PLEASE CALL 715-355-8842 AND TALK TO YOUR CTECH REPRESENTATIVE TODAY. \*



<b>SPECIFICATIONS:</b>	<b>PC724236H</b>
<b>WIDTH</b>	<b>72"</b>
<b>HEIGHT</b>	<b>42"</b>
<b>DEPTH</b>	<b>36"</b>
<b>LOAD CAPACITY</b>	<b>250 lbs per drawer/shelf</b>
<b>DRAWERS</b>	<b>2-3", 3-4"</b>
<b>NET WEIGHT</b>	<b>503 lbs</b>
<b>MSRP</b>	<b>\$5,604.50</b>



- WORK TOP CART - PC724236H**
- (5) MotionLatch™ drawers  
-250 lbs load rating per drawer  
-heavy duty liner
  - (5) MotionLatch™ doors
  - Adjust-A-Loc Shelves
  - (3) MotionLatch™ doors (chassis)
  - Dual-sided storage
  - Heavy Duty push/pull/steering T-handle
  - 16" Pneumatic Tires
  - Optional Hydraulic Brakes
  - Built in D-Rings



REVERSE SIDE

<b>SPECIFICATIONS:</b>	<b>PC724236L</b>
<b>WIDTH</b>	<b>72"</b>
<b>HEIGHT</b>	<b>42"</b>
<b>DEPTH</b>	<b>36"</b>
<b>LOAD CAPACITY</b>	<b>250 lbs per drawer/shelf</b>
<b>DRAWERS</b>	<b>2-3", 3-4"</b>
<b>NET WEIGHT</b>	<b>523 lbs</b>
<b>MSRP</b>	<b>\$5,890.50</b>



- WORK TOP CART - PC724236HN - Nitrogen Cradle**
- (5) MotionLatch™ drawers  
-250 lbs load rating per drawer  
-heavy duty liner
  - (5) MotionLatch™ doors
  - Adjust-A-Loc Shelves
  - (3) MotionLatch™ doors (chassis)
  - Dual-sided storage
  - Heavy Duty push/pull/steering T-handle
  - 16" Pneumatic Tires
  - Optional Hydraulic Brakes
  - Built in D-Rings
  - Nitrogen Bottle Cradle (chassis)



REVERSE SIDE  
**NITROGEN STORAGE**

**POWDER COAT COLORS:**



\* ANY STANDARD PRODUCT CAN BE CUSTOMIZED TO YOUR SPECIFIC NEEDS, PLEASE CALL 715-355-8842 AND TALK TO YOUR CTECH REPRESENTATIVE TODAY. \*





<b>SPECIFICATIONS:</b>	<b>PC724236M</b>
<b>WIDTH</b>	<b>72"</b>
<b>HEIGHT</b>	<b>42"</b>
<b>DEPTH</b>	<b>36"</b>
<b>LOAD CAPACITY</b>	<b>250 lbs per drawer/shelf</b>
<b>DRAWERS</b>	<b>4-3", 6-4"</b>
<b>NET WEIGHT</b>	<b>622 lbs</b>
<b>MSRP</b>	<b>\$6,678.10</b>

**WORK TOP CART - PC724236MN - Nitrogen Cradle**

- (10) MotionLatch™ drawers  
-250 lbs load rating per drawer  
-heavy duty liner
- (4) MotionLatch™ doors
- Adjust-A-Loc Shelves
- (3) MotionLatch™ doors (chassis)
- Dual-sided storage
- Heavy Duty push/pull/steering T-handle
- 16" Pneumatic Tires
- Optional Hydraulic Brakes
- Built in D-Rings
- Nitrogen Bottle Cradle (chassis)



REVERSE SIDE

**NITROGEN STORAGE**

**POWDER COAT COLORS:**



\* ANY STANDARD PRODUCT CAN BE CUSTOMIZED TO YOUR SPECIFIC NEEDS, PLEASE CALL 715-355-8842 AND TALK TO YOUR CTECH REPRESENTATIVE TODAY. \*





# PRO SERIES CARTS



All Pro Series carts offer dual-sided storage and chassis storage, while the Crew Chief cart features an additional option to enclose that work surface. The design of the cart opens it to an array of add-on accessories making it very popular in the racing industry. All MotionLatch™ drawers and shelves are equipped with heavy duty liners and are rated for 250lbs. MotionLatch™ doors offer easy access storage. Available in 12 standard powder coat colors, many standard configurations, and many customizable add-ons to make one all your own.





<b>SPECIFICATIONS:</b>	<b>PC606736E</b>
<b>WIDTH</b>	<b>60"</b>
<b>HEIGHT</b>	<b>67"</b>
<b>DEPTH</b>	<b>36"</b>
<b>LOAD CAPACITY</b>	<b>250 lbs per drawer/shelf</b>
<b>DRAWERS</b>	<b>2-3", 1-4", 1-5", 1-6"</b>
<b>NET WEIGHT</b>	<b>576 lbs</b>
<b>MSRP</b>	<b>\$6,264.50</b> *

**CREW CHIEF CART - PC606736E**

- (5) MotionLatch™ drawers  
-250 lbs load rating per drawer  
-heavy duty liner
- (8) MotionLatch™ doors
- Adjust-A-Loc Shelves
- (4) MotionLatch™ doors (chassis)
- Dual-sided storage
- Enclosed Work Surface with Flip Up Trigger Latch Door
- Heavy Duty push/pull/steering T-handle
- 16" Pneumatic Tires
- Optional Hydraulic Brakes
- Built in D-Rings
- Nitrogen Bottle Cradle (chassis)



REVERSE SIDE

\* shown with optional door

<b>SPECIFICATIONS:</b>	<b>PC726736F</b>
<b>WIDTH</b>	<b>72"</b>
<b>HEIGHT</b>	<b>67"</b>
<b>DEPTH</b>	<b>36"</b>
<b>LOAD CAPACITY</b>	<b>250 lbs per drawer/shelf</b>
<b>DRAWERS</b>	<b>2-3", 1-4", 1-5", 1-6"</b>
<b>NET WEIGHT</b>	<b>637 lbs</b>
<b>MSRP</b>	<b>\$7,034.50</b> *

**CREW CHIEF CART - PC726736F**

- (5) MotionLatch™ drawers  
-250 lbs load rating per drawer  
-heavy duty liner
- (8) MotionLatch™ doors
- Adjust-A-Loc Shelves
- (4) MotionLatch™ doors (chassis)
- Dual-sided storage
- Enclosed Work Surface with Flip Up Trigger Latch Door
- Heavy Duty push/pull/steering T-handle
- 16" Pneumatic Tires
- Optional Hydraulic Brakes
- Built in D-Rings
- Nitrogen Bottle Cradle (chassis)



**NITROGEN STORAGE**

\* shown with optional door

REVERSE SIDE

**POWDER COAT COLORS:**



\* ANY STANDARD PRODUCT CAN BE CUSTOMIZED TO YOUR SPECIFIC NEEDS, PLEASE CALL 715-355-8842 AND TALK TO YOUR CTECH REPRESENTATIVE TODAY. \*



<b>SPECIFICATIONS:</b>	<b>PC726736G</b>
<b>WIDTH</b>	<b>72"</b>
<b>HEIGHT</b>	<b>67"</b>
<b>DEPTH</b>	<b>36"</b>
<b>LOAD CAPACITY</b>	<b>250 lbs per drawer/shelf</b>
<b>DRAWERS</b>	<b>3X - 3-4", 1-8"</b>
<b>NET WEIGHT</b>	<b>754 lbs</b>
<b>MSRP</b>	<b>\$9,894.50</b>

**SPORTSMAN CART - PC726736G - Nitrogen Cradle**

- (12) MotionLatch™ drawers  
-250 lbs load rating per drawer  
-heavy duty liner
- (9) MotionLatch™ doors
- Adjust-A-Loc Shelves
- (3) MotionLatch™ doors (chassis)
- Dual-sided storage
- (3) Nitrogen Bottle Cradle (upper)
- (1) Nitrogen Bottle Cradle (chassis)
- Heavy Duty push/pull/steering T-handle
- Pneumatic Tires
- Optional Hydraulic Brakes
- Built in D-Rings

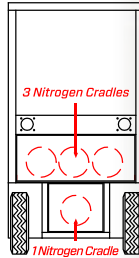

REVERSE SIDE



<b>SPECIFICATIONS:</b>	<b>PC966736A</b>
<b>WIDTH</b>	<b>96"</b>
<b>HEIGHT</b>	<b>67"</b>
<b>DEPTH</b>	<b>36"</b>
<b>LOAD CAPACITY</b>	<b>250 lbs per drawer/shelf</b>
<b>DRAWERS</b>	<b>3X - 3-4", 1-8"</b>
<b>NET WEIGHT</b>	<b>861 lbs</b>
<b>MSRP</b>	<b>\$14,294.50</b>

**SPORTSMAN CART - PC966736A - Nitrogen Cradle**

- (12) MotionLatch™ drawers  
-250 lbs load rating per drawer  
-heavy duty liner
- (10) MotionLatch™ doors
- Adjust-A-Loc Shelves
- (5) MotionLatch™ doors (chassis)
- Dual-sided storage
- (3) Nitrogen Bottle Cradle (upper)
- (1) Nitrogen Bottle Cradle (chassis)
- Heavy Duty push/pull/steering T-handle
- Pneumatic Tires
- Optional Hydraulic Brakes
- Built in D-Rings



REVERSE SIDE

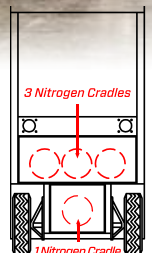

**POWDER COAT COLORS:**



\* ANY STANDARD PRODUCT CAN BE CUSTOMIZED TO YOUR SPECIFIC NEEDS, PLEASE CALL 715-355-8842 AND TALK TO YOUR CTECH REPRESENTATIVE TODAY. \*





<b>SPECIFICATIONS:</b>	<b>PC967242C</b>
<b>WIDTH</b>	<b>96"</b>
<b>HEIGHT</b>	<b>72"</b>
<b>DEPTH</b>	<b>42"</b>
<b>LOAD CAPACITY</b>	<b>250 lbs per drawer/shelf</b>
<b>DRAWERS</b>	<b>3X - 1-3", 2-4", 2-5", 1-6"</b>
<b>NET WEIGHT</b>	<b>1027 lbs</b>
<b>MSRP</b>	<b>\$14,850.00</b>



- SPORTSMAN CART - PC967242C - Nitrogen Cradle**
- (18) MotionLatch™ drawers  
-250 lbs load rating per drawer  
-heavy duty liner
  - (7) MotionLatch™ doors
  - Adjust-A-Loc Shelves
  - (5) MotionLatch™ doors (chassis)
  - Dual-sided storage
  - (2) Nitrogen Bottle Cradle (chassis)
  - Ship-To-Shore Power Inlet
  - Lights and Outlets in 18" deep workspace
  - Heavy Duty push/pull/steering T-handle
  - Pneumatic Tires
  - Optional Hydraulic Brakes
  - Built in D-Rings

REVERSE SIDE

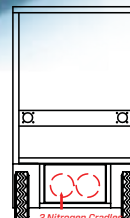

<b>SPECIFICATIONS:</b>	<b>PC1207036D</b>
<b>WIDTH</b>	<b>120"</b>
<b>HEIGHT</b>	<b>70"</b>
<b>DEPTH</b>	<b>36"</b>
<b>LOAD CAPACITY</b>	<b>250 lbs per drawer/shelf</b>
<b>DRAWERS</b>	<b>3X - 2-3", 1-4", 1-6", 1-8"</b>
<b>NET WEIGHT</b>	<b>1122 lbs</b>
<b>MSRP</b>	<b>\$18,694.50</b>

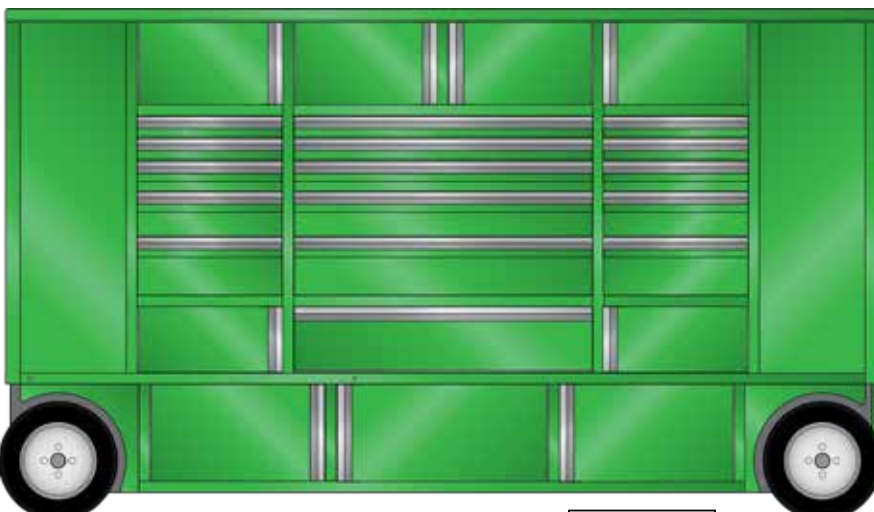

- SPORTSMAN CART - PC1207036D - Nitrogen Cradle**
- (15) MotionLatch™ drawers  
-250 lbs load rating per drawer  
-heavy duty liner
  - (14) MotionLatch™ doors (cart)
  - Adjust-A-Loc Shelves
  - (7) MotionLatch™ doors (chassis)
  - Dual-sided storage
  - Flip Down Work Bench
  - (3) Nitrogen Bottle Cradle (upper)
  - (1) Nitrogen Bottle Cradle (chassis)
  - Heavy Duty push/pull/steering T-handle
  - Pneumatic Tires
  - Optional Hydraulic Brakes
  - Built in D-Rings

REVERSE SIDE

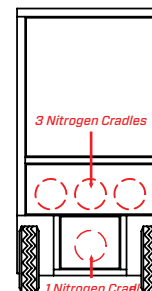

**POWDER COAT COLORS:**



\* ANY STANDARD PRODUCT CAN BE CUSTOMIZED TO YOUR SPECIFIC NEEDS, PLEASE CALL 715-355-8842 AND TALK TO YOUR CTECH REPRESENTATIVE TODAY. \*

# GARAGE BOX



- MotionLatch™ drawers
- MotionLatch™ doors
- Door mounted monitor opening
- Polished Stainless work station
- Steering linkage with built-in negative caster
- 4-wheel steering
- Flat Free Tires with Hydraulic Brakes
- Industrial grade Flat Free Wheels with Hydraulic Brakes (optional)
- 2 sided storage
- Ship-to-Shore power with two 50' electric reels
- Exterior lighting
- Chassis storage
- **Available in 69" and 72" heights**



## POWDER COAT COLORS:

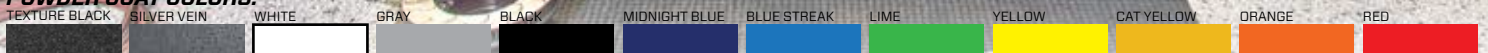

\* ANY STANDARD PRODUCT CAN BE CUSTOMIZED TO YOUR SPECIFIC NEEDS, PLEASE CALL 715-355-8842 AND TALK TO YOUR CTECH REPRESENTATIVE TODAY. \*



The same FEATURES and OPTIONS as the "ORIGINAL" with a new open concept work surface.

# GARAGE BOX NEW STYLE



## OPEN UP YOUR WORK AREA



AVAILABLE IN  
**69" & 72" heights**  
to fit your trailer requirements

**POWDER COAT COLORS:**



\* ANY STANDARD PRODUCT CAN BE CUSTOMIZED TO YOUR SPECIFIC NEEDS, PLEASE CALL 715-355-8842 AND TALK TO YOUR CTECH REPRESENTATIVE TODAY. \*

CARTS

# 72" FUEL CART



## 72" FUEL CART

- 4 Nitrogen Cradles
  - 2 in chassis, 2 in center section
- MotionLatch™ drawers
- MotionLatch™ doors
- Nitrogen regulator gauge panels
- Specialized sub-frame to support rail system
- Fuel Rail Track extends 36" (not including fuel storage canister)
- Leveling stabilizers
- Hydraulic Disc Brakes
- Manual actuated hydraulic lift on fuel tank

**MANEUVERABILITY and FLEXIBILITY are key in the new 72" Fuel Cart offerings!**



## NEW STYLE

## 72" INDY FUEL CART

- 4 Nitrogen Cradles
  - 2 inch chassis and 2 below 8inch drawer
- MotionLatch™ drawers
- MotionLatch™ doors
- Nitrogen regulator gauge panels
- Indy Fuel Tank on pneumatic Lift Table w/ Accordion Skirt
- NEW STYLE removable Leveling stabilizers
- Hydraulic Disc Brakes
- Flip down work station at rear of Dog House



## NEW STYLE - MOST MANEUVERABLE FOR TIGHT PIT AREAS

## 72" BAD ASS FUEL CART

- 2 Nitrogen Cradles
- MotionLatch™ drawers
- MotionLatch™ doors
- Nitrogen regulator gauge panels
- Specialized sub-frame to support rail system
- NEW STYLE removable Leveling stabilizers
- Bad Ass Casters: 2 swivel with brakes, 2 fixed
- Custom push/pull handle
- Flip down work station at rear of Dog House



### POWDER COAT COLORS:



\* ANY STANDARD PRODUCT CAN BE CUSTOMIZED TO YOUR SPECIFIC NEEDS, PLEASE CALL 715-355-8842 AND TALK TO YOUR CTECH REPRESENTATIVE TODAY. \*



# 84" FUEL CART

Approx Weight:  
**1060 lbs**

- 5 Nitrogen Bottle Capacity
  - 2 in chassis
  - 3 in center section
- MotionLatch™ drawers
- MotionLatch™ doors
- 6" cutout for boom installation
- 2 recessed nitrogen gauge panels
- Specialized sub-frame to support rail system
- Fuel Rail Track extends 36" (not including fuel storage canister)
- 6 leveling stabilizers
- Hydraulic Disc Brakes
- Manual actuated hydraulic lift on fuel tank
- Optional tank surround and beauty panels available



**RECESSED NITROGEN GAUGE PANEL**



**NITROGEN CRADLE FULL LENGTH BALL BEARINGS**



*Optional Dog House Storage*



*Tank Surround*

**POWDER COAT COLORS:**



\* ANY STANDARD PRODUCT CAN BE CUSTOMIZED TO YOUR SPECIFIC NEEDS, PLEASE CALL 715-355-8842 AND TALK TO YOUR CTECH REPRESENTATIVE TODAY. \*





# PREMIUM OBSERVATION

## 72", 84", 96"

AVAILABLE LENGTHS

Approx Weight:

## 1261 lbs

- Fold down adjustable monitor array w/ 5 detachable monitors
  - prepped for 2 quick detach monitors under media deck
- MotionLatch™ drawers & doors
- Multiple work stations with laptop storage
- Onboard seating with work stations
- Pneumatic Tires with Hydraulic Brakes
- Industrial-grade Flat Free Wheels with Hydraulic Brakes (optional)
- Removable T-Pull Handle with quick disconnect Brake
- Nitrogen tank cradle + Full Length Ball Bearings
- Ship-to-Shore power
  - 6-15 AMP breaker panel
- Slide out ladder
- Chassis storage







# 72,84" TIMING / SCORING STAND

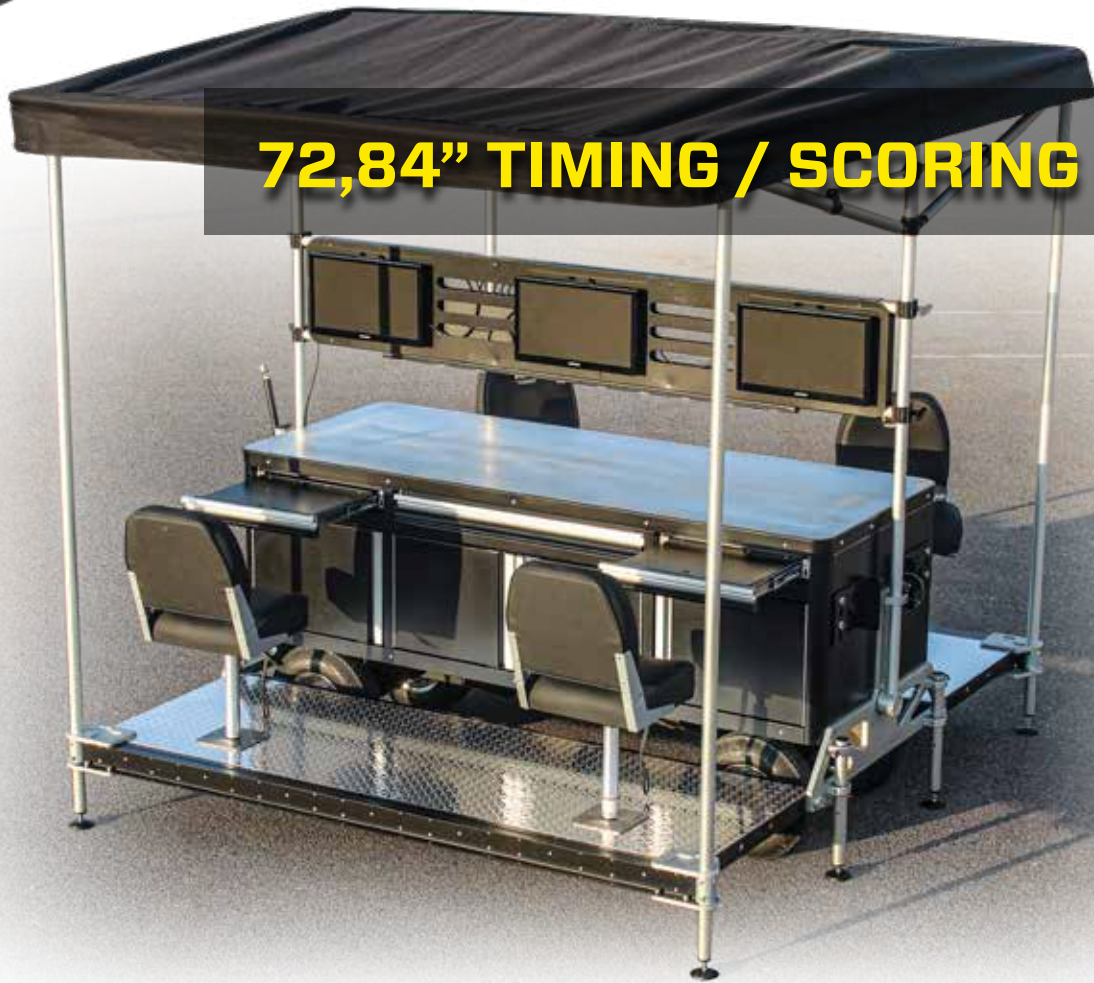

- MotionLatch™ drawers
- MotionLatch™ doors
- Stabilizers
- Multiple work stations with laptop storage
- Electric monitor array
- Multiple monitor configurations
- Steering linkage with built-in negative caster
- Removable pedestal seating
- Billet aluminum deck mounts
- Diamond plate deck floor
- 2-sided storage
- Ship-to-Shore power
- Chassis storage
- Available with or without a canopy



## POWDER COAT COLORS:



\* ANY STANDARD PRODUCT CAN BE CUSTOMIZED TO YOUR SPECIFIC NEEDS, PLEASE CALL 715-355-8842 AND TALK TO YOUR CTECH REPRESENTATIVE TODAY. \*



# 104" TIMING / SCORING STAND

- MotionLatch™ drawers
- MotionLatch™ doors
- 4 Leveling stabilizers
- Multiple work stations with laptop storage
- Electric monitor array
- 2-42" & 8-19" LED TVs
- Steering linkage with built-in negative caster
- Removable pedestal seating up to 8
- Billet aluminum deck mounts
- 3 Nitrogen tank cradles
- Full Length Ball Bearings
- 2-sided storage
- Ship-to-Shore power with 6-15 AMP breaker panel
- (4) Cat 5 and 110 electrical outlets each end
- Chassis storage

**DOUBLE DECK OPTION**



**MONITORS RAISED  
94" TALL  
MONITORS LOWERED  
75" TALL**

**POWDER COAT COLORS:**



\* ANY STANDARD PRODUCT CAN BE CUSTOMIZED TO YOUR SPECIFIC NEEDS, PLEASE CALL 715-355-8842 AND TALK TO YOUR CTECH REPRESENTATIVE TODAY. \*







*Shown with optional  
RACE DAY CANOPY*

## JR TRANSPORTER

- Fold down monitor array w/ 3 monitors
- Prepped for 2 quick detach monitors under media deck
- MotionLatch™ drawers, MotionLatch™ doors
- 4 Leveling stabilizers
- Multiple work stations with laptop storage
- Steering linkage with built-in negative caster
- Removable pedestal seating up to 8
- Billet aluminum deck mounts and all aluminum deck
- 2 pedestal seats or 1 bench seat
- Nitrogen tank cradle
- Full Length Ball Bearings
- 2-sided storage
- Ship-to-Shore power
- Slide out ladder
- Chassis storage



*Approx Weight:  
**1024 lbs***



***COLLAPSE FOR TRANSPORT***

72" L x 42.5" W x 69" H



25

BMW Team

## TWIN PLATFORM JR TRANSPORTER

BMW of North America

BMW of North America

- 2 Jr Tranporter Carts designed to be mirror images of each other. This is the perfect setup for multiple-car teams.
- Available with an optional connection deck, which connects the 2 carts for a more convenient twin deck setup.

OPTIONAL  
CONNECTION  
DECK

"We chose CTECH's twin cart setup because of the diversity the carts offer. This setup is the answer for any 2 car team. The carts can be joined together or used independently. The media deck allows multi-level viewing for sponsors and team owners. With top quality in design and construction CTECH carts are easily transported and moved in and out of the pit."

-Steve Dickson  
Rahal Letterman Lanigan  
General Manager

**POWDER COAT COLORS:**

\* ANY STANDARD PRODUCT CAN BE CUSTOMIZED TO YOUR SPECIFIC NEEDS, PLEASE CALL 715-355-8842 AND TALK TO YOUR CTECH REPRESENTATIVE TODAY. \*



# TRANSPORTER

- Fold down adjustable monitor array w/ 5 detachable monitors
  - prepped for 4 quick detach monitors under media deck
- 2 monitor doors (monitors optional)
- 2 fold down stainless work surfaces
- MotionLatch™ drawers & doors
- 4 Leveling stabilizers
- Multiple work stations with laptop storage
- Steering linkage with built-in negative caster
- Removable pedestal seating or bench seats as shown
  - Transport bags included
- Rear deck railing and detachable ladder with storage bags
- Billet aluminum deck mounts and all aluminum deck
  - 4 pedestal seats or 2 bench seat
- 4 wheel steering
- Twin nitrogen tank cradle - Full Length Ball Bearings
- 2 nitrogen regulator panels
- Ship-to-Shore power with 6-15 AMP breakers
  - 3 Cat 5 outlets, 9-110 Volt outlets
- Chassis storage



**THE ONLY 120" TRANSPORTABLE OBSERVATION  
CART WITH A REAR DECK THAT FITS IN THE  
AISLE-WAY OF YOUR TRAILER!**

Approx Weight:  
**1840 lbs**

**C-TECH**  
MANUFACTURING  
OFFICIAL CART PROVIDER

**IMSA**  
**WeatherTech**  
SPORTSCAR CHAMPIONSHIP

AND THE TEAMS IT SUPPORTS





# ULTRA CART EXTENDED DECK

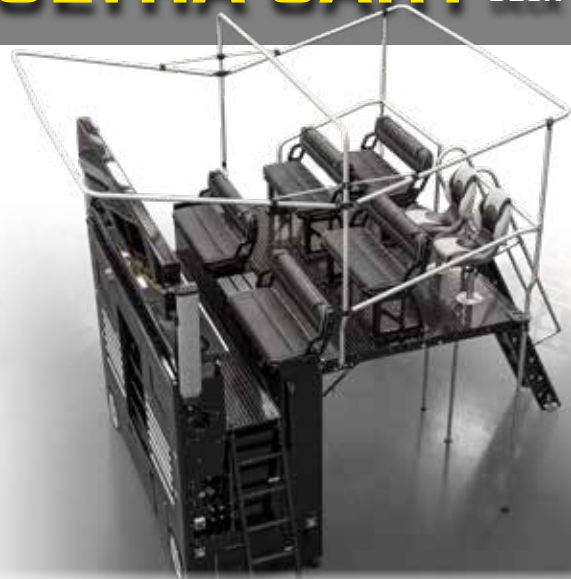

- Fold down adjustable monitor array w/ 5 detachable monitors
- Prepped for 4 quick detach monitors under media deck
- Laptop MotionLatch™ aluminum storage drawers and lids with pre-wired 110 Volt receptacles and VGA connection
- Slide out mount for 42" flat screen monitor- under deck
- Large side pod doors for bulky item storage
- 60" storage drawer on cart end (Coffin Drawer)
- Rack mount area for battery backups and IT equipment
- Enclosed generator slide-out with venting
- Aerosol can slide out drawer
- 2 adjustable pit pole mounts
- Nitrogen regulator panels, hold 4 regulators
- 3 Nitrogen Cradles, full length ball bearings
- 2 monitor doors (monitors optional)
- 2 fold down stainless work surfaces
- 4 Automatic Leveling stabilizers
- Rear deck railing and detachable ladder with storage bags
- Billet aluminum deck mounts and diamond plate deck
- Standard Media Deck: 4 pedestal seats or 2 bench seats
- Extended Media Deck: 8 pedestal seats or 4 bench seats
- Under deck LED lighting
- Flat Free Tires
- Hydraulic Brakes
- 4 wheel no scrub steering
- Ceramic bearings

Approx Weight:  
**3500 lbs**



#### POWDER COAT COLORS:

TEXTURE BLACK SILVER VEIN



\* ANY STANDARD

ORANGE RED



AVAILABLE TODAY.\*





# ULTRA CART DUAL DECK

*PIT WALL WILL NEVER BE THE SAME!*



**THE NEXT LEVEL**  
IN TRACK SIDE  
ENTERTAINING WITH  
**CTECH MANUFACTURING**



**120" L x 66" W x 89" H**  
**213" With Decks Extended**

### Monocoque Chassis

- Heavy duty all aluminum chassis with steel support braces to handle heavy load
- Counter balance system to assist deck lifting
- Three nitrogen cradles
- Flat free tires mounted on custom
- Billet aluminum wheels allows for effortless motion
- Four wheel steering and all wheel disc brakes

### POWDER COAT COLORS:



\* ANY STANDARD PRODUCT CAN BE CUSTOMIZED TO YOUR SPECIFIC NEEDS, PLEASE CALL 715-355-8842 AND TALK TO YOUR CTECH REPRESENTATIVE TODAY. \*





### **Cart Configuration:**

#### **Non Track End**

- 40" built in Monitor
- Electrical Panel
- Antenna Mount
- Nitrogen Bottle Storage Access

#### **Track End**

- 40" Built in Monitor
- Electrical Panel
- Nitrogen Bottle Storage Access
- 4 MotionLatch Drawer Bank
- Built In slide out Tool Storage
- 2 x the Branding opportunity than any other cart on pit lane.

#### **Right Side**

- 4 Lower Chassis Storage Doors for Additional Storage
- Internal wiring chase with 110 volt receptacles and VGA connections
- 40" TV / Monitor slide out for easily access to Rear TV Connections

- 2-22" Monitors
- 5 Motion Latch Drawers
- 16 Dual Equipment Racking with 2 single

#### **Left Side**

- 4 Lower Chassis Storage Doors for Additional Storage
- Internal wiring chase with 110 volt receptacles and VGA connections
- 40" TV / Monitor slide out for easy access to Rear TV Connections
- 2-22" Monitors
- 5 MotionLatch Drawers
- Work Station with 2 adjustable shelves
- Removable Panel with Access to back of Equipment Racking
- Aerosol Can Storage Slide Out

#### **Dual Deck Configuration:**

- All Aluminum Deck with a Diamond Plate Surface
- 9 prewired 110-volt receptacles for monitor video feed
- 5-22" Monitors
- Seating to Accommodate:
  - 4 Bench Seats
  - 9 Pedestal Seats
  - 2 Tables
- Twin Grab Handles
- All Aluminum High Tensile Railing System with Quick Detach
- CTECH Ultra Efficient Race Day Canopy System
- All Aluminum Deck Ladders with High Tensile Hand Railing System.

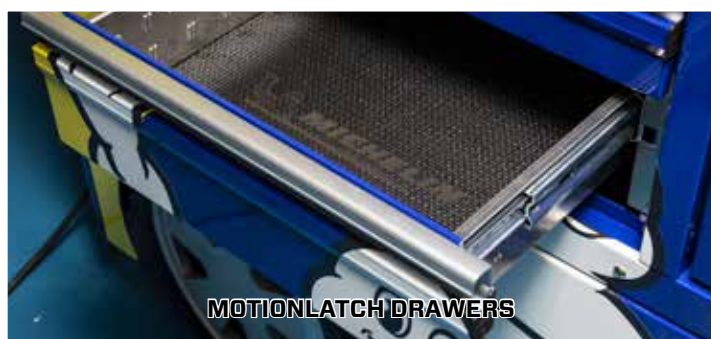

# CART OPTIONS

\* ANY STANDARD PRODUCT CAN BE CUSTOMIZED TO YOUR SPECIFIC NEEDS, PLEASE CALL 715-355-8842 AND TALK TO YOUR CTECH REPRESENTATIVE TODAY. \*

## TIE-DOWNS:



Removable Tie-Down Hooks



Built in D-Rings



Billet Aluminum D-Rings

## PUSH/PULL HANDLES:



No handle  
- Service, Caster, Bad Ass Caster



Fold Away Handle  
- Service, Caster, Bad Ass Caster

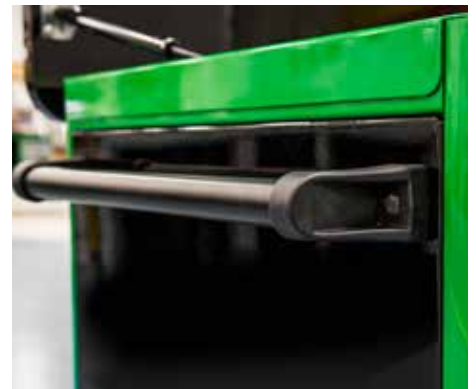

Heavy Duty Push / Pull Handle  
- Service, Caster, Bad Ass Caster



T-Handle  
- Hot Rod, Mini, Work Top & Pro



Heim Joint  
- Hot Rod, Mini, Work Top & Pro



Pintle Hook  
- Service, Caster, Bad Ass Caster



TOP OPTIONS:



Fixed Top (DA sanded, or powder coated)

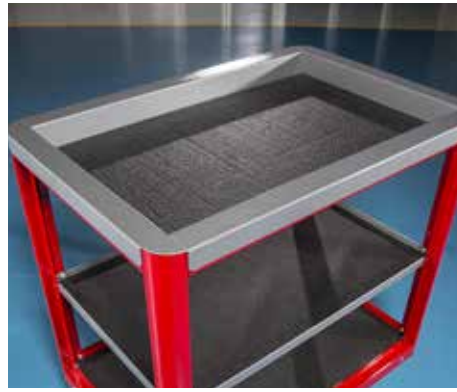

Inverted Top



Flip Lid

TOP ADD ONS:



Peg Board Surround



Back Splash



Liner Top Cover



Stainless Steel Overlay



1/4" UHMW Overlay



Butcher Block



Removable Tire Rack

POWER OPTIONS:



Ship-To-Shore Power  
- weather resilient mobile power inlet



Electrical Reel



Pre-Wired Options  
- HDMI, USB, RCA, and Power

PLUMBING OPTIONS:



Air Hose Reel



Regulators



Integrated Air Compressor

ADDITIONAL OPTIONS:



Nitrogen Cradles



Cart Stabilizers



Overhead Storage



Receiver Vise Insert



Vent Panel, Door, or Floor



Sink Insert



Charging Station



Monitor Doors



Observation Deck Seating



ADDITIONAL OPTIONS:



Bench Cushion



Injection Molded Display Components



Removable Exterior Shelving



End Panel Door and Tag Board



Hydraulic Disc Brakes



Cart Cover



Race Day Canopy



Display Rack and Shelving



Canopy Monitor Mount







CTech is no stranger to pit row at any event. CORE Autosports has an attractive pit setup utilizing a Jr. Transporter and Fuel Cart for their race day storage needs.

## RACING CARTS

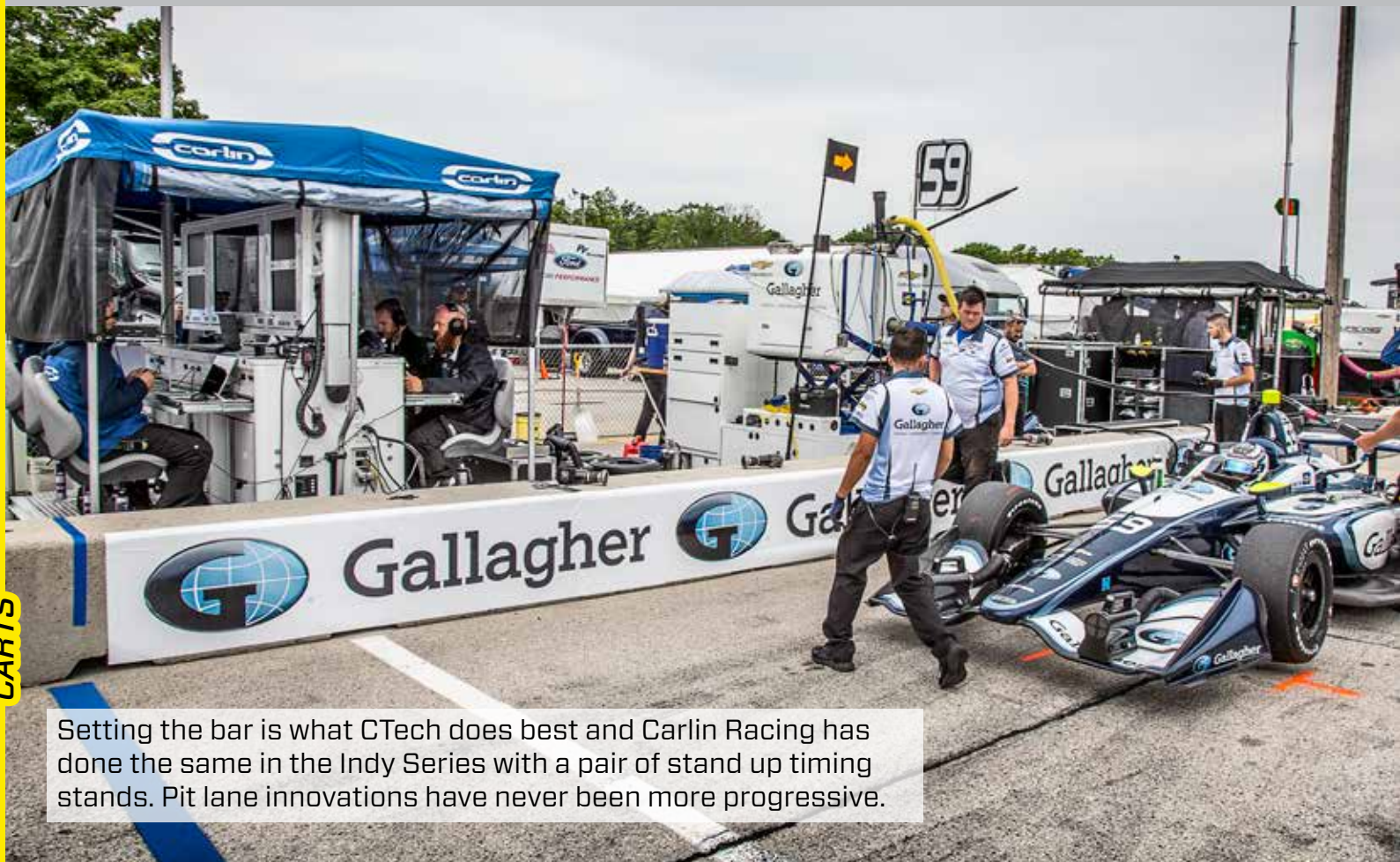

Setting the bar is what CTech does best and Carlin Racing has done the same in the Indy Series with a pair of stand up timing stands. Pit lane innovations have never been more progressive.





Twin Platforms offer a great collaborative deck area for 2 car teams. BMW USA has a beautiful pit lane presence.

**THE ONLY 120" TRANSPORTABLE OBSERVATION CART WITH A REAR DECK THAT FITS IN THE AISLE OF YOUR TRAILER!**



WeatherTech and Scuderia Corsa demand a professional pit row, in appearance, as well as function, which is why they choose CTech as their storage solution!



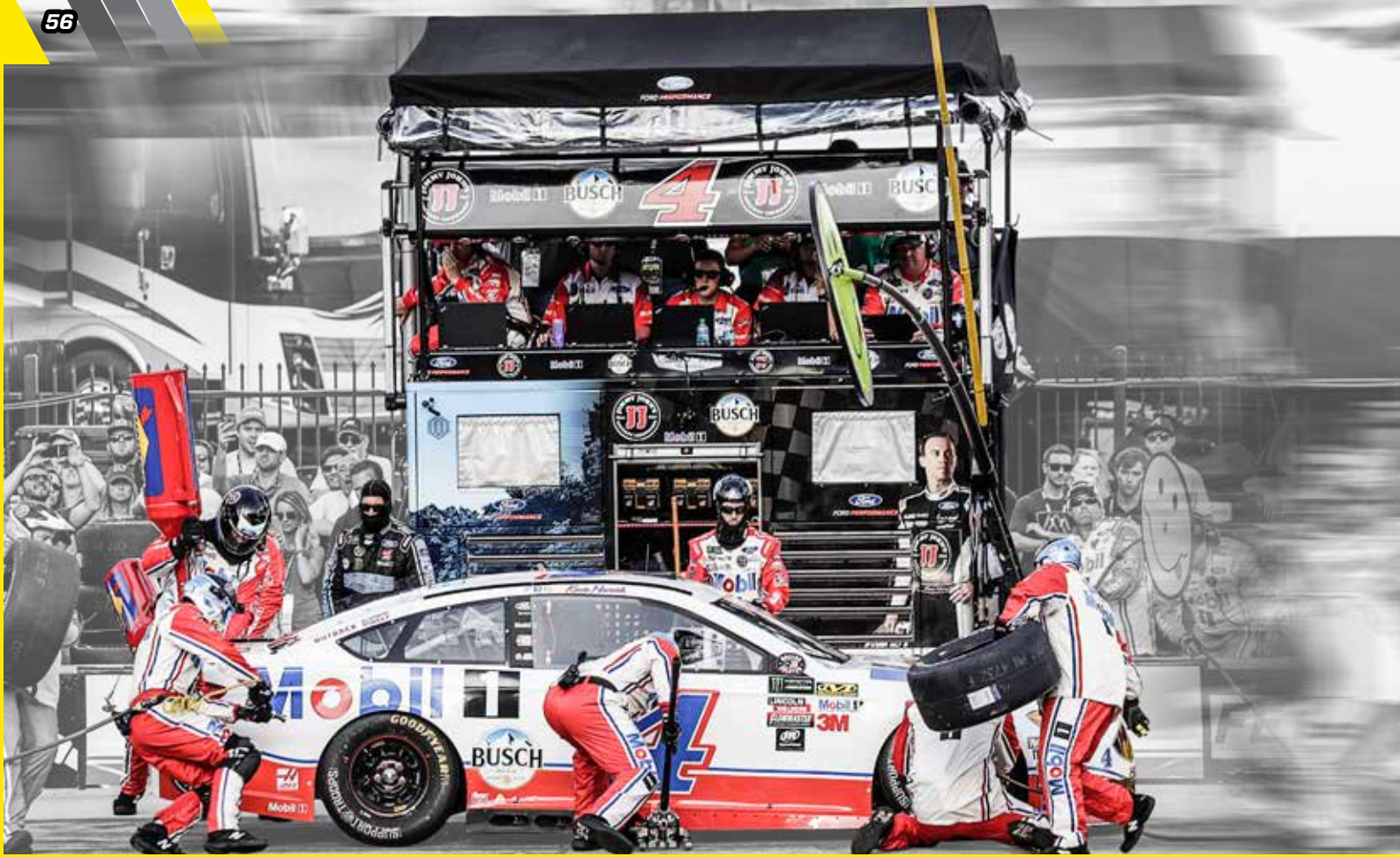

# DECK CARTS

- **Motorsports**
- **Entertainment**
- **Owners Deck**
- **Media Coverage**
- **Hospitality**



*The possibilities*





**2019 NASCAR XFINITY - CTech Manufacturing 180 @ Road America**

The CTech car took the pole and led most of the race!  
Team Kaulig Racing and driver AJ Allmendinger did a great job.



- Construction
- Oil Field
- Industrial
- Military
- Engineering Support

**CARTS**

*are endless...*





Digital communication carts designed for sideline communication for a National Sporting League. Built on a Mini Cart and Bad Ass Caster Cart chassis.

# INDUSTRIAL CARTS



Mobile workstations built on the Hot Rod chassis. These carts are designed to the customer's specifications for storage with electrical pre-wired and MotionLatch™ adjustable shelves.



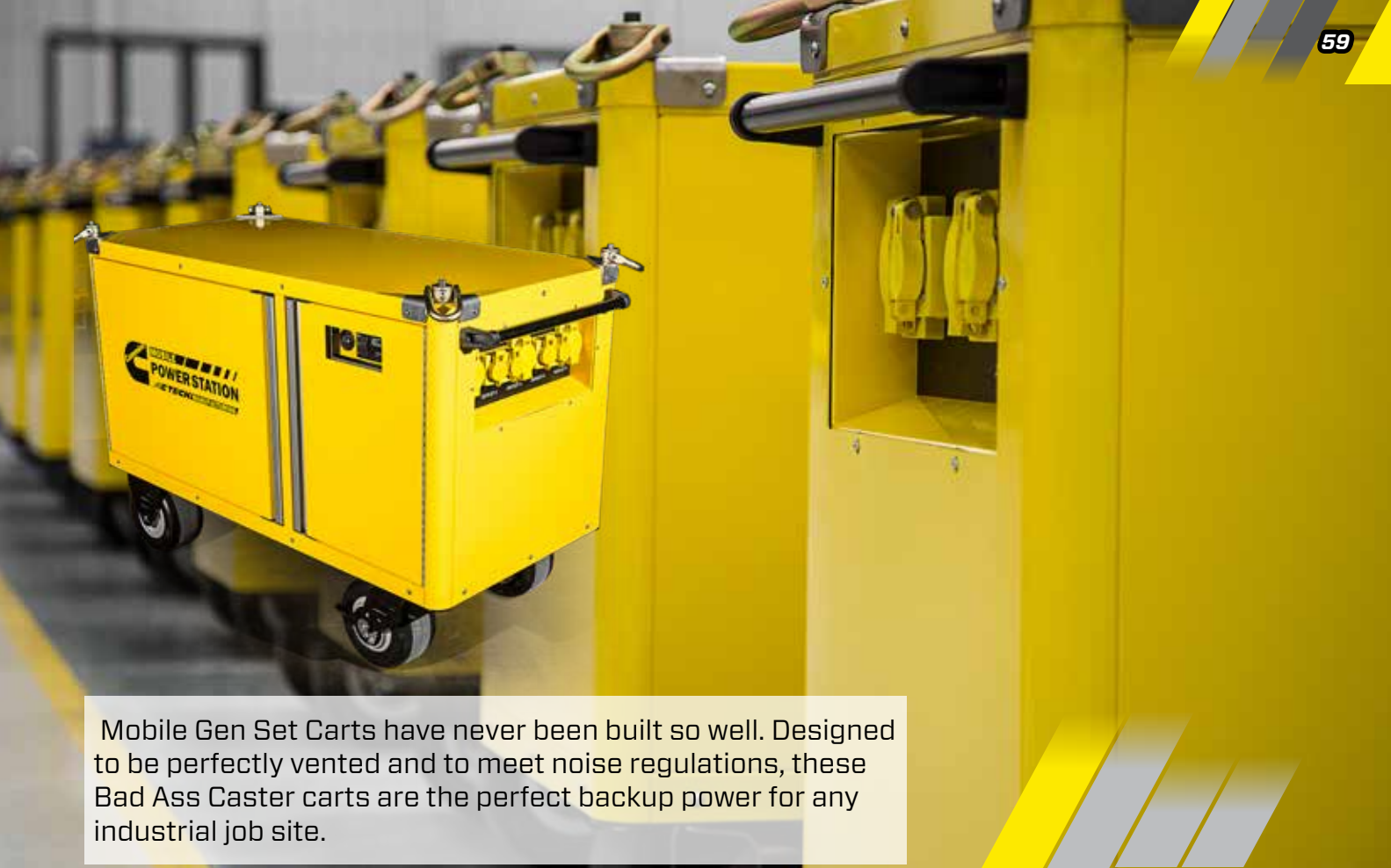

Mobile Gen Set Carts have never been built so well. Designed to be perfectly vented and to meet noise regulations, these Bad Ass Caster carts are the perfect backup power for any industrial job site.



Outfitting a lab with workstations similar to these at North Central Technical College provide the mobility of a cart and the work area of a counter. These also add extra storage space for an organized and efficient environment.



***AUTOMOTIVE***



***BUSINESS & MARKETING***



***CONSTRUCTION***





*MILITARY / DEFENSE*



*EDUCATION*



*PROFESSIONAL SPORTS*



*AEROSPACE*



*INDUSTRIAL*



*GRAPHICS / PRINTING*





*RETAIL*



*FACILITIES MANAGEMENT*



*MOTORSPORTS*





# *BLACKLINE*

EFFICIENCY AND ORGANIZATION OPTIONS





# *ACCESSORIES*





SPECIFICATIONS:	BL-ACC-10
<b>DIMENSIONS</b>	4.25"W x 8.5"D
<b>MSRP</b>	\$25.00

BLACKLINE - BL-ACC-10  
*Rag In A Box Holder*

- Securely holds "Rags in a box"
- Rag box is not included
- May fit other rag boxes as well



SPECIFICATIONS:	BL-ACC-11
<b>DIMENSIONS</b>	12"W x 17"D
<b>MSRP</b>	\$100.00

BLACKLINE - BL-ACC-11  
*Water Jug Rack*

- Holds 1-3 gallon jugs
- Jug not included



SPECIFICATIONS:	BL-ACC-5
<b>DIMENSIONS</b>	13.625"W x 7.1875"D
<b>MSRP</b>	\$85.00

BLACKLINE - BL-ACC-5  
*Paper Towel Dispenser*

- Prevents paper towel from unrolling
- easy paper change



SPECIFICATIONS:	BL-ACC-9
<b>DIMENSIONS</b>	36"W x 14"H
<b>MSRP</b>	\$190.00

BLACKLINE - BL-ACC-9  
*Fuel Jug Rack*

- Holds 3-5 gallon fuel jugs
- add a second mount kit to move mount from trailer to pit area



SPECIFICATIONS:	BL-ACC-2
<b>DIMENSIONS</b>	25.5"W x 10"H
<b>MSRP</b>	\$65.00

BLACKLINE - BL-ACC-2  
*Bottle Rack*

- Organize your bottles and cans



SPECIFICATIONS:	BL-ACC-8
<b>DIMENSIONS</b>	25.5"W x 10"H
<b>MSRP</b>	\$65.00

BLACKLINE - BL-ACC-8  
*Aerosol Can Rack*

- Holds up to 7 aerosol cans firmly in place



SPECIFICATIONS:	BL-ACC-7
<b>DIMENSIONS</b>	49.25"W x 20.165"H - OPEN 49.25"W x 6" - CLOSED
<b>MSRP</b>	\$430.00

BLACKLINE - BL-ACC-7  
*Flip-Down Bench*

- Quick fold away work surface
- add a second mount kit to move from the interior to the exterior of your trailer



SPECIFICATIONS:	BL-ACC-3
<b>DIMENSIONS</b>	49.25"W x 24.75"H - OPEN 49.25"W x 9" - CLOSED
<b>MSRP</b>	\$600.00

BLACKLINE - BL-ACC-3  
*Fold-Up Bench - Heavy Duty*

- Heavy duty additional work surface
- Stainless Steel top
- Bottle rack storage





SPECIFICATIONS:	BL-ACC-6
<b>DIMENSIONS</b>	20"W x 26.75"H
<b>MSRP</b>	\$465.00

BLACKLINE - BL-ACC-6  
*Charging / Radio Station*

- 2 accessory shelves
- 7-110v duplex receptacles



SPECIFICATIONS:	BL-ACC-12
<b>DIMENSIONS</b>	25.5"W x 24"H
<b>MSRP</b>	\$600.00

BLACKLINE - BL-ACC-12  
*Hanging MotionLatch™ Drawer Cabinet*

- Hemmed shelf work station
- 1-2", 2-4" MotionLatch™ Drawers



SPECIFICATIONS:	BL-ACC-4
<b>DIMENSIONS</b>	25.5"W x 50.5"H
<b>MSRP</b>	\$325.00

BLACKLINE - BL-ACC-4  
*Accessory Rack*

- 2- Bottle/Can racks
- 1- Aerosol Can rack
- 1- Paper towel dispenser



SPECIFICATIONS:	BL-ACC-1
<b>DIMENSIONS</b>	25.5"W x 46"H
<b>MSRP</b>	\$760.00

BLACKLINE - BL-ACC-1  
*Drawer Cabinet w/Accessory Rack*

- 1- Bottle/Can racks
- 1- Aerosol Can rack
- Hemmed shelf work station
- 1-2", 2-4" MotionLatch™ Drawers



SPECIFICATIONS:	BL-ACC-MOUNTKIT
<b>DIMENSIONS</b>	NA
<b>MSRP</b>	\$20.00

- BLACKLINE - BL-ACC-MOUNTKIT
- Molded from non-marring composite material
  - 4 QuickMounts per kit
  - Perfect addition to any existing accessory for added mount locations.

# WE BUILD

## CARTS

- RACE
- INDUSTRIAL
- CUSTOM

## CABINETS

- GARAGE
- SHOP
- TRAILER



# IT BETTER

- HOUSING INSERT
- CABINET INSERT
- TOOL DRAWER INSERT

## DRAWERS

## TACTICAL

- LAW ENFORCEMENT
- FIRE/EMT
- MILITARY

For more information on our capabilities check us out at [WWW.CTECHMANUFACTURING.COM](http://WWW.CTECHMANUFACTURING.COM)

# **CTech Manufacturing Policies and Procedures**

**Terms** - Standard terms for approved accounts are Net 30-days. Non-compliance to the terms may result in a late fee of up to 2% per month.

**Cancellation and Change Policy** - Orders canceled more than 24 hours from time of receipt are subject to a cancellation fee of up to 20%. Cancellation or changes must come in writing (not verbal) and be confirmed within 24 hours of the original purchase order being issued to avoid any potential change or cancellation fees.

**Return Policy** - Custom built products are non-returnable. Standard products are subject to a return fee of up to 20% plus the cost of freight to return the product. Products must have been purchased within the past 12 months. All returned products must be in like new, sale-able condition. Any returned products **MUST** have a Return Goods Authorization approved before returning. Any returns without a pre-approved RGA will be rejected and returned to sender.

**Warranty Policy** - CTech Manufacturing offers a limited lifetime warranty\* against any manufacturing defects in material or workmanship so long as the original purchaser retains ownership, possession, and control of the product.

\* **Note** - Slides are a purchased product and are warranted for one year from date of original invoice. Slides are passed through to the original manufacturer for inspection and processing.



**50%**

**WEIGHT SAVINGS**

on average over a steel comparison



CTech Manufacturing is a Wisconsin based company dedicated to customer satisfaction, quality products and industry leading innovations.

**WE BUILD IT BETTER**

**CTECH**

*We've taken the guess work out - easier to do business with*

***With over 20 years of experience, CTech has established itself as the most respected name in manufactured aluminum carts, cabinets and drawers for mobile applications. Our customer relationships help drive our business in new directions and keep CTech the leader of pack.***



**QUOTING**

*Standard product requests will be quoted in 1 working business days time.*

*\*Custom quoting will require extra time dependent on multiple factors.*



**DRAWER UNIT LEAD TIME**

*Standard product of 10 units or less will ship in 10 days of the order confirmation.*

*\*Custom projects or larger quantity orders are a case by case and lead times will be communicated before the order is placed.*



**PRODUCT LEAD TIME**

*From the time your order with CTECH to the day it ships is 30 days or less.*

*\*Custom projects may take more time due to engineering time.*

**WWW.CTECHMANUFACTURING.COM**



**CTECH EXCLUSIVE**  
**MotionLatch™**  
**Drawer & Door System**  
US Patent 6,547,289

*CTECH Manufacturing*  
7501 Commerce Dr  
Weston, WI 54476  
(p) 715-355-8842  
(f) 715-355-8932

© All Rights Reserved 2019 CTECH Manufacturing - 102019



*The one and only MotionLatch!*  
*Only available from CTEch, don't be fooled by imitators*