



# MASTER CATALOG

Aluminum CARTS, CABINET, DRAWERS, and TACTICAL Solutions

**WE BUILD IT BETTER**



**U.S.A. MADE**

715.355.8842 - [WWW.CTECHMANUFACTURING.COM](http://WWW.CTECHMANUFACTURING.COM)

**CTECH**  
MANUFACTURING  
ALUMINUM CARTS, CABINETS & DRAWERS

*With a passion for racing, Jim Greenheck, CTech Manufacturing President/ Owner, needed a quality storage solution when on the road with his drag car. Jim sought after his own design and built the first CTech cabinet. He took into consideration "MOBILE APPLICATION" when engineering the first CTech products and that still holds true to this day.*

*CTech was developed to be lighter, stronger, and of a higher quality than anything else available. By concentrating on product innovation and listening to our customers, we have maintained our reputation for being the most respected name in storage products!*

*These innovations have grown our product offerings to include all-aluminum carts, cabinets, drawers and tactical cabinets. These products cover a number of different industries which continue to evolve and grow with each request. Our products have been used in a variety of mobile and stationary applications.*

*CTech stays engaged with customers to deliver new and innovative solutions every day. From major race teams to global energy companies, our people, technology, and engineering practices allow us to continue this trend of innovation.*

## **WE BUILD IT BETTER**

**NO MATTER WHAT INDUSTRY  
WE GUARANTEE A SUPERIOR PRODUCT**



*CTech added 80,000 sq ft to its manufacturing facility in 2018 to better serve current customers and answer an increased demand for new business.*



# TABLE OF CONTENTS



<b>FEATURES:</b>	6-9	<b>PRO SERIES CARTS:</b>	32-35
<b>SERVICE CARTS:</b>	10-11	<b>OPTIONS:</b>	36-39
<b>CASTER CARTS:</b>	12-15	<b>CUSTOM CARTS:</b>	
<b>BAD ASS CASTER CARTS:</b>	16-19	<b>Racing/Pit Carts:</b>	40-41
<b>HOT ROD CARTS:</b>	20-21	<b>Deck Carts:</b>	42-43
<b>MINI CARTS:</b>	22-27	<b>Industrial Carts:</b>	44-45
<b>WORKTOP CARTS:</b>	28-31	<b>INDUSTRIES SERVED:</b>	46-49

CARTS



<b>FEATURES:</b>	52-55	<b>VAN / TRUCK:</b>	76-77
<b>ECONO SERIES:</b>	56-59	<b>OPTIONS:</b>	78-81
<b>Packages:</b>	57-58	<b>CUSTOM CABINETS:</b>	
<b>Components:</b>	59	<b>Garage:</b>	82-83
<b>PRO SERIES:</b>	60-69	<b>Shop:</b>	84-85
<b>Packages:</b>	61-66	<b>Trailer:</b>	86-87
<b>Components:</b>	67-69	<b>Specialty Vehicle:</b>	88-89
<b>ULTRA SERIES:</b>	70-75	<b>UTV Cabinet:</b>	90-91
<b>Packages:</b>	71-73	<b>INDUSTRIES SERVED:</b>	92-95
<b>Components:</b>	74-75		

CABINETS



<b>FEATURES:</b>	98-99	<b>Palfinger:</b>	121-123
<b>INSERT STYLES:</b>	100	<b>Royal:</b>	124-130
<b>BOLT BINS:</b>	101	<b>BOLT BINS:</b>	
<b>STANDARD UNITS:</b>		<b>Standard:</b>	131
<b>Knapheide:</b>	103-106	<b>Configurable:</b>	132
<b>IMT:</b>	107-110	<b>OBSTRUCTION GUIDE:</b>	133
<b>Auto Crane:</b>	111-115	<b>COMPARTMENT MEASURING:</b>	134
<b>Brand FX:</b>	116-117	<b>OPTIONS:</b>	135-137
<b>Monroe:</b>	118-119	<b>CUSTOM DRAWERS:</b>	138-143
<b>NorStar:</b>	120		

DRAWERS



<b>FEATURES:</b>	146-149	<b>OPTIONS:</b>	160-161
<b>COPBOX CABINETS:</b>		<b>MODEL OVERVIEW:</b>	162-163
<b>Metro Series:</b>	151	<b>CUSTOM TACTICAL:</b>	
<b>Responder Series:</b>	151-152	<b>Truck Bed:</b>	164-165
<b>Patrol Series:</b>	152	<b>SUV:</b>	166-167
<b>Tactical Series:</b>	152-153	<b>Large Truck/Van:</b>	168-169
<b>Command Series:</b>	154-155	<b>Custom Configurations:</b>	170-171
<b>Scale Series:</b>	155		
<b>Commander Series:</b>	156		
<b>Fire Series:</b>	156		
<b>TROOPER SERIES:</b>	159		

TACTICAL



<b>ACCESSORIES:</b>	174-175
<b>PRODUCT PORTFOLIO:</b>	176-177
<b>POLICIES &amp; PROCEDURES:</b>	178
<b>CTECH ADVANTAGE:</b>	179

BLACKLINE

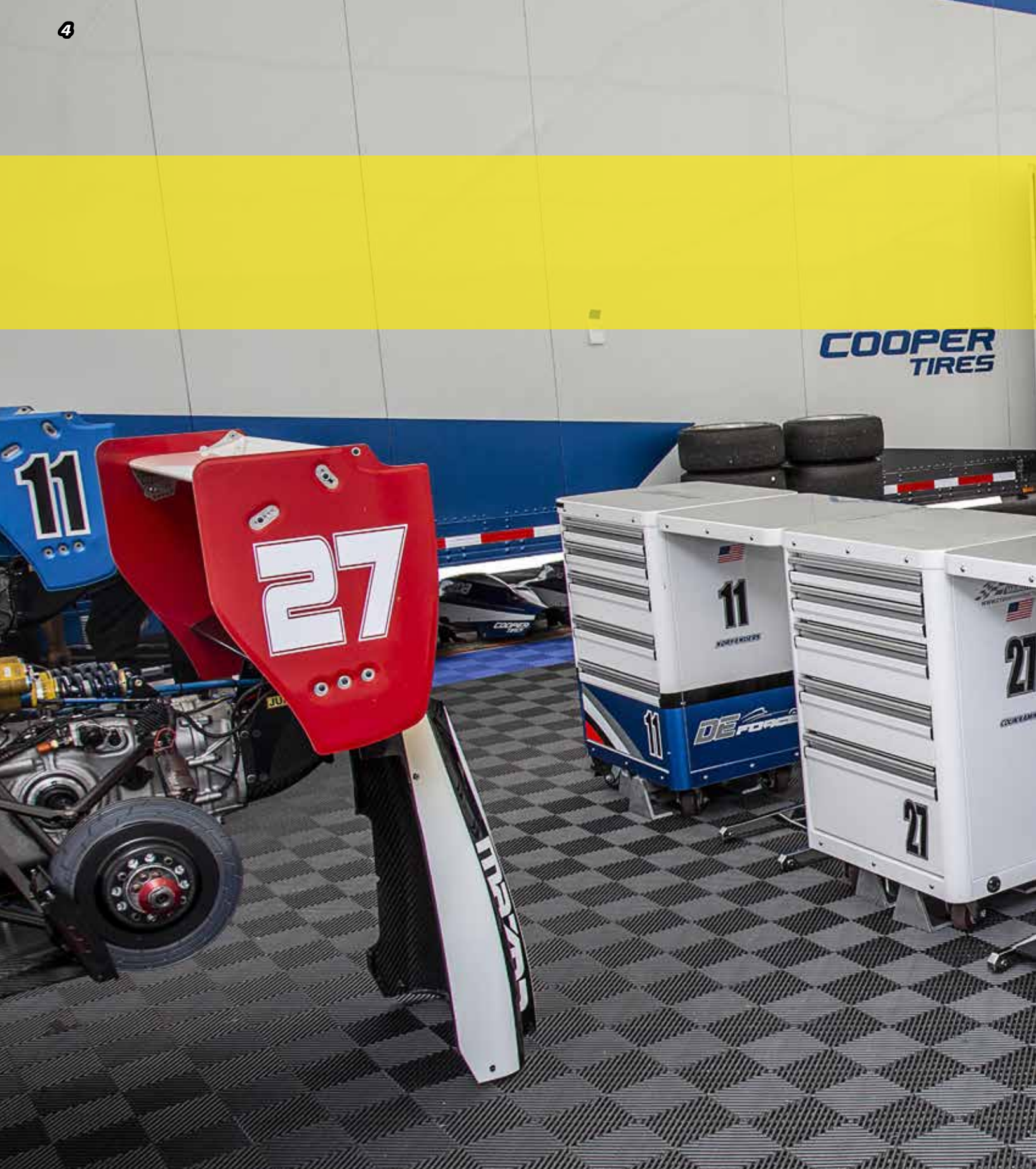

**TOOL STORAGE TO GO!** AT THE TRACK, IN THE TRAILER, OR IN THE SHOP



# CARTS



**ALWAYS ON THE JOB**



**Shown with optional features:**

- Removable Tire Rack
- Race Day Canopy
- Black Anodized Handles

**Adjustable Shelving**

-Storage requirements change from time to time, let your storage solution change with it. Adjust your shelves or add more as needed.

**Radius Corners**

-Radius "snag free" corners set CTech carts apart from our competitors in functionality, construction, and aesthetics.

**Heavy Duty Handle**

-Multiple styles available based on cart.

**MotionLatch™ Doors**

-The ONLY door latch with a full length grab area!

**Built in "D" Rings**

- Optional for each cart style, CTech offers multiple styles of tie down rings for transport.

**Heavy Duty Wheels**

- Heavy Duty Casters, Bad Ass Caster, Flat Free or Pneumatic tire options are available to fit any function.

**MotionLatch™ Drawers**

- "ONE HAND - ONE MOTION" opening function lets you grab anywhere on the extruded aluminum handle and effortlessly open our 250lb rated drawers.



**5052**  
ALUMINUM  
BODY PANELS

EXTRUDED  
ALUMINUM FRAME



**RADIUS  
CORNERS**  
FASTENER ASSEMBLED

FEATURES WITH (\*) CAN BE SEEN IN THE EXPANDED FEATURE DESCRIPTIONS ON THE FOLLOWING PAGES





Engineered with strong aluminum extrusions

**INDUSTRY FIRST!**

**MOTIONLATCH™ DRAWERS & DOORS**

- Offers “ONE HAND - ONE MOTION” operation even with a handful of tools.
- No pinching, no squeezing, no twisting, just pull the handle and the latches release.
- MotionLatch™ opening function lets you grab anywhere on the extruded aluminum handle and effortlessly open our 250lb rated drawers.



Dual-composite latches stay closed

**CTECH EXCLUSIVE**  
**MotionLatch™**  
**Drawer & Door System**  
 US Patent 6,547,289

**CTECH EXCLUSIVE**  
**2" RADIUS CORNERS**



Radius extrusion corner and extrusion framework



***EXTRUDED RADIUS CORNERS***  
***with FASTENER ASSEMBLY***

- Snag-Free 2" radius corner eliminates sharp edges for a safe and efficient working area.
- All-aluminum extrusion framework provides durable construction at a fraction of the weight.
- Engineered with fastener assembly to withstand harsh mobile applications and challenging terrain.



Mechanically fastened





4" Caster



10" Bad Ass Caster  
- ALL TERRAIN



10" Flat Free Wheel



16" Pneumatic Wheel

**PREMIUM WHEELS**  
**for PREMIUM CARTS**

- Heavy Duty 4" Rigid Casters with brakes - quality heavy duty casters for quality carts
- Extreme Duty 10" Bad Ass Casters with brakes - designed for all-terrain applications
- Flat Free tires and Billet Aluminum wheels standard with brakes
- Pneumatic tires and Polished wheels - hydraulic disc brakes optional
- Industrial Grade Flat Free tires with steel wheels - Hydraulic disc brakes optional, best performing wheels with heavily-loaded carts



16" Flat Free Wheel



# SERVICE CARTS



The versatile service cart or shop cart, is the heavy duty solution for any job. Great for temporary storage of tools, parts and supplies during a task. This handy cart helps eliminates the time associated with walking back and forth to your toolbox or bench. All shelves and drawers are equipped with heavy duty liner. The removable inverted top makes for easy clean up. Available in 12 standard powder coat colors with many customizable add-ons to make one all your own.

4" SWIVEL CASTERS



LOCKED







<b>SPECIFICATIONS:</b>	<b>CC363624A</b>
WIDTH	36"
HEIGHT	36"
DEPTH	24"
LOAD CAPACITY	250 lbs per shelf (750lbs)
DRAWERS	NA
NET WEIGHT	75 lbs
MSRP	\$581.90

### SERVICE CART - CC363624A

- Inverted top (removable)
- Heavy duty casters
- Extruded aluminum frame
- Radius corners - snag free
- (1) Shelf with heavy duty liner

<b>SPECIFICATIONS:</b>	<b>CC363624D</b>
WIDTH	36"
HEIGHT	36"
DEPTH	24"
LOAD CAPACITY	250 lbs per shelf/drawer (1000lbs)
DRAWERS	1- 4"
NET WEIGHT	100 lbs
MSRP	\$713.90

### SERVICE CART - CC363624D

- (1) 4" MotionLatch™ drawer
- Inverted top (removable)
- Heavy duty casters
- Extruded aluminum frame
- Radius corners - snag free
- (1) Shelf with heavy duty liner



### POWDER COAT COLORS:

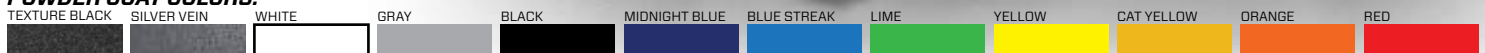

\* ANY STANDARD PRODUCT CAN BE CUSTOMIZED TO YOUR SPECIFIC NEEDS, PLEASE CALL 715-355-8842 AND TALK TO YOUR CTECH REPRESENTATIVE TODAY. \*



# CASTER CARTS



If you are looking for the most durable caster cart in a 1, 2, or 3 opening configuration, look no further. Our heavy duty casters (2 swivel with brakes, 2 fixed) are ideal for any hard surface and roll with ease even with the heaviest supplies. All MotionLatch™ drawers and shelves are equipped with heavy duty liner and rated for 250lbs. MotionLatch™ doors offer easy access with a secure closure. Available in 10 standard powder coat colors, 12 standard configurations, and many customizable add-ons to make one all your own.

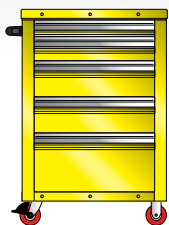

**TYPE 1**

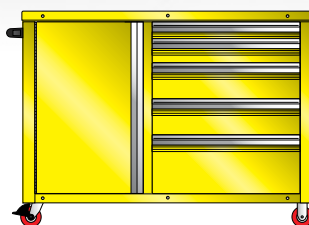

**TYPE 2**

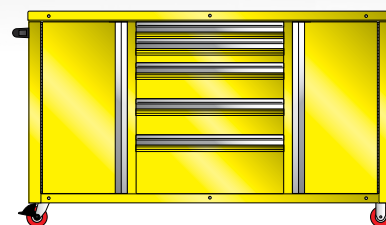

**TYPE 3**



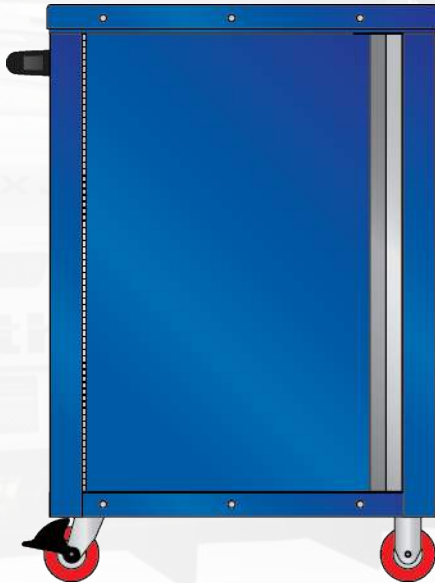

<b>SPECIFICATIONS:</b>	<b>CC244024A</b>
<b>WIDTH</b>	<b>24"</b>
<b>HEIGHT</b>	<b>40"</b>
<b>DEPTH</b>	<b>24"</b>
<b>LOAD CAPACITY</b>	<b>250 lbs per drawer/shelf</b>
<b>DRAWERS</b>	<b>NA</b>
<b>NET WEIGHT</b>	<b>83 lbs</b>
<b>MSRP</b>	<b>\$1,204.50</b>

#### CASTER CART - CC244024A - TYPE 1

- (1) MotionLatch™ door
- Adjust-A-Loc Shelves
- Heavy Duty push/pull handle
- Heavy duty casters
- Extruded aluminum framework
- Radius corners - snag free

<b>SPECIFICATIONS:</b>	<b>CC244024C</b>
<b>WIDTH</b>	<b>24"</b>
<b>HEIGHT</b>	<b>40"</b>
<b>DEPTH</b>	<b>24"</b>
<b>LOAD CAPACITY</b>	<b>250 lbs per drawer</b>
<b>DRAWERS</b>	<b>1-3", 1-4", 2-6", 1-10"</b>
<b>NET WEIGHT</b>	<b>165 lbs</b>
<b>MSRP</b>	<b>\$2,084.50</b>

#### CASTER CART - CC244024C - TYPE 1

- (5) MotionLatch™ drawers  
-250 lbs load rating per drawer + heavy duty liner
- Heavy Duty push/pull handle
- Heavy duty casters
- Extruded aluminum framework
- Radius corners - snag free



<b>SPECIFICATIONS:</b>	<b>CC244024E</b>
<b>WIDTH</b>	<b>24"</b>
<b>HEIGHT</b>	<b>40"</b>
<b>DEPTH</b>	<b>24"</b>
<b>LOAD CAPACITY</b>	<b>250 lbs per drawer/shelf</b>
<b>DRAWERS</b>	<b>1-4"</b>
<b>NET WEIGHT</b>	<b>93 lbs</b>
<b>MSRP</b>	<b>\$1,375.00</b>

#### CASTER CART - CC244024E - TYPE 1

- (1) MotionLatch™ drawer  
-250 lbs load rating per drawer + heavy duty liner
- (1) MotionLatch™ door
- Adjust-A-Loc Shelves
- Heavy Duty push/pull handle
- Heavy duty casters
- Extruded aluminum framework
- Radius corners - snag free

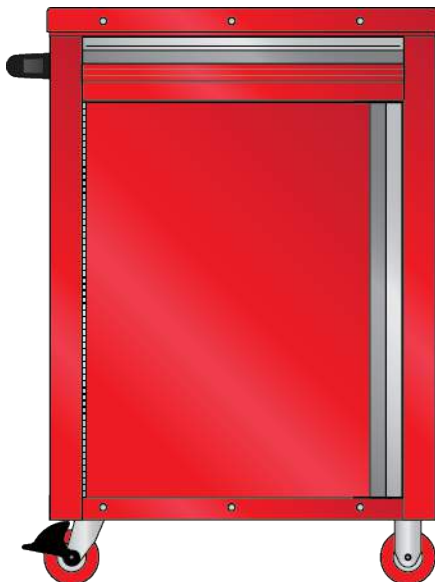

#### POWDER COAT COLORS:



\* ANY STANDARD PRODUCT CAN BE CUSTOMIZED TO YOUR SPECIFIC NEEDS, PLEASE CALL 715-355-8842 AND TALK TO YOUR CTECH REPRESENTATIVE TODAY. \*

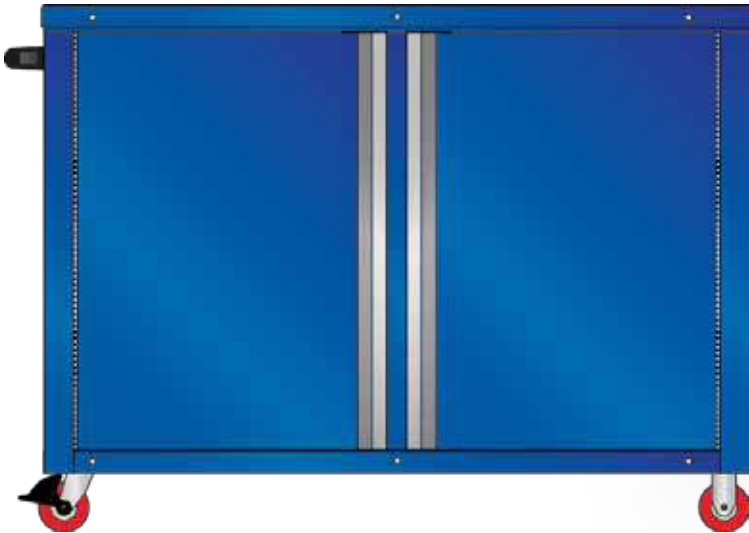

<b>SPECIFICATIONS:</b>	<b>CC484024A</b>
<b>WIDTH</b>	<b>48"</b>
<b>HEIGHT</b>	<b>40"</b>
<b>DEPTH</b>	<b>24"</b>
<b>LOAD CAPACITY</b>	<b>250 lbs per shelf</b>
<b>DRAWERS</b>	<b>NA</b>
<b>NET WEIGHT</b>	<b>126 lbs</b>
<b>MSRP</b>	<b>\$1,703.90</b>

CASTER CART - CC484024A - TYPE 2

- (2) MotionLatch™ door
- Adjust-A-Loc Shelves
- Heavy Duty push/pull handle
- Heavy duty casters
- Extruded aluminum framework
- Radius corners - snag free

<b>SPECIFICATIONS:</b>	<b>CC484024C</b>
<b>WIDTH</b>	<b>48"</b>
<b>HEIGHT</b>	<b>40"</b>
<b>DEPTH</b>	<b>24"</b>
<b>LOAD CAPACITY</b>	<b>250 lbs per shelf</b>
<b>DRAWERS</b>	<b>1-3", 1-4", 2-6" and 1-10"</b>
<b>NET WEIGHT</b>	<b>200 lbs</b>
<b>MSRP</b>	<b>\$2,704.90</b>

CASTER CART - CC484024C - TYPE 2

- (5) MotionLatch™ drawers -250 lbs load rating per drawer + heavy duty liner
- (1) MotionLatch™ door
- Adjust-A-Loc Shelves
- Heavy Duty push/pull handle
- Heavy duty casters
- Extruded aluminum framework
- Radius corners - snag free



<b>SPECIFICATIONS:</b>	<b>CC484024E</b>
<b>WIDTH</b>	<b>48"</b>
<b>HEIGHT</b>	<b>40"</b>
<b>DEPTH</b>	<b>24"</b>
<b>LOAD CAPACITY</b>	<b>250 lbs per shelf</b>
<b>DRAWERS</b>	<b>2-4"</b>
<b>NET WEIGHT</b>	<b>157 lbs</b>
<b>MSRP</b>	<b>\$2,062.50</b>

CASTER CART - CC484024E- TYPE 2

- (2) MotionLatch™ drawers -250 lbs load rating per drawer + heavy duty liner
- (2) MotionLatch™ door
- Adjust-A-Loc Shelves
- Heavy Duty push/pull handle
- Heavy duty casters
- Extruded aluminum framework
- Radius corners - snag free

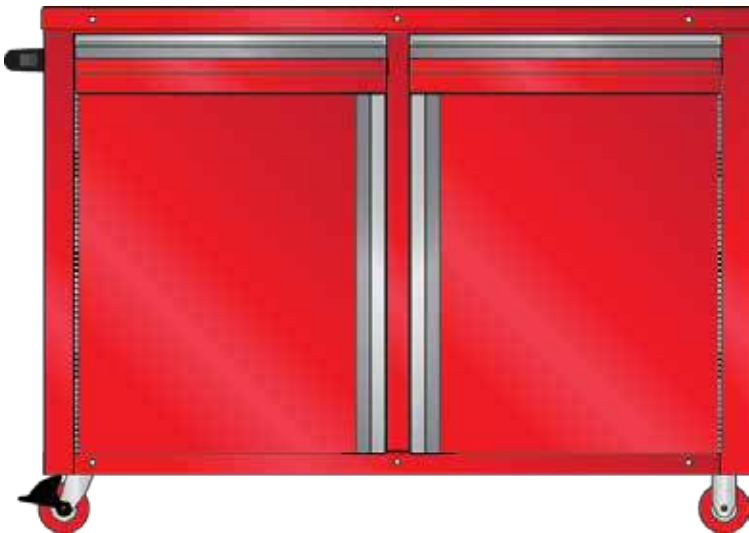

**POWDER COAT COLORS:**



\* ANY STANDARD PRODUCT CAN BE CUSTOMIZED TO YOUR SPECIFIC NEEDS, PLEASE CALL 715-355-8842 AND TALK TO YOUR CTECH REPRESENTATIVE TODAY. \*





SPECIFICATIONS:	CC604024A	CC724024A
WIDTH	60"	72"
HEIGHT	40"	40"
DEPTH	24"	24"
LOAD CAPACITY	250 lbs per shelf	250 lbs per shelf
DRAWERS	NA	NA
NET WEIGHT	154 lbs	169 lbs
MSRP	\$2,084.50	\$2,264.90

CASTER CART - TYPE 3

- (3) MotionLatch™ door
- Adjust-A-Loc Shelves
- Heavy Duty push/pull handle
- Heavy duty casters
- Extruded aluminum framework
- Radius corners - snag free



SPECIFICATIONS:	CC604024C	CC724024C
WIDTH	60"	72"
HEIGHT	40"	40"
DEPTH	24"	24"
LOAD CAPACITY	250 lbs per shelf	250 lbs per shelf
DRAWERS	1-3", 1-4", 2-6" and 1-10"	1-3", 1-4", 2-6" and 1-10"
NET WEIGHT	248 lbs	262 lbs
MSRP	\$2,915.00	\$3,019.50

CASTER CART - TYPE 3

- (5) MotionLatch™ drawers  
-250 lbs load rating per drawer + heavy duty liner
- (2) MotionLatch™ door
- Adjust-A-Loc Shelves
- Heavy Duty push/pull handle
- Heavy duty casters
- Extruded aluminum framework
- Radius corners - snag free



SPECIFICATIONS:	CC604024E	CC724024E
WIDTH	60"	72"
HEIGHT	40"	40"
DEPTH	24"	24"
LOAD CAPACITY	250 lbs per shelf	250 lbs per shelf
DRAWERS	3-4"	3-4"
NET WEIGHT	201 lbs	213 lbs
MSRP	\$2,585.00	\$2,744.50

CASTER CART - TYPE 3

- (3) MotionLatch™ drawers  
-250 lbs load rating per drawer + heavy duty liner
- (3) MotionLatch™ door
- Adjust-A-Loc Shelves
- Heavy Duty push/pull handle
- Heavy duty casters
- Extruded aluminum framework
- Radius corners - snag free



POWDER COAT COLORS:



\* ANY STANDARD PRODUCT CAN BE CUSTOMIZED TO YOUR SPECIFIC NEEDS, PLEASE CALL 715-355-8842 AND TALK TO YOUR CTECH REPRESENTATIVE TODAY. \*



# BAD ASS CASTER CARTS

## -THE LEADING ALL TERRAIN CASTER

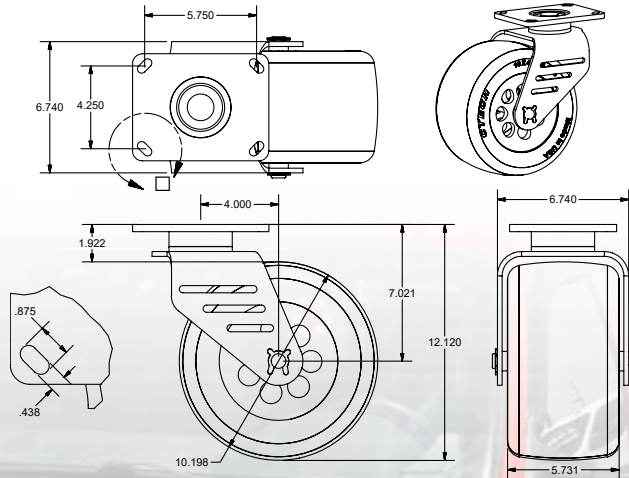

The 10" Bad Ass Caster allows for easy maneuverability over all terrains. Designed to roll like a pneumatic tire while maintaining the load capacities of a caster. These carts are designed for extreme conditions for a caster application and outfitted with 2 swivels with brakes and 2 fixed casters on all standard carts.







<b>SPECIFICATIONS:</b>	<b>BA464830A</b>
WIDTH	48"
HEIGHT	48.5"
DEPTH	30"
LOAD CAPACITY	250 lbs per drawer/shelf
DRAWERS	2-3", 2-4" 1-5", 3-6", 1-8", 1-9", 1-10"
NET WEIGHT	466 lbs
MSRP	\$6,374.50

#### BAD ASS MECHANIC CART - BA464830A

- (11) MotionLatch™ drawers  
-250 lbs load rating per drawer + heavy duty liner
- Locking drawers
- Heavy Duty push/pull handle
- 10" all terrain Bad Ass Casters  
-2 swivel with brakes, 2 fixed
- Flip top storage
- Extruded aluminum frame work
- Radius corners - snag free
- Two-toned powder coat optional (pictured)

# NEVER BE LIMITED TO THE SHOP FLOOR AGAIN!

<b>SPECIFICATIONS:</b>	<b>BA564830B</b>
WIDTH	56"
HEIGHT	48"
DEPTH	30"
LOAD CAPACITY	250 lbs per drawer/shelf
DRAWERS	4-4", 1-5", 3-6", 1-10"
NET WEIGHT	500 lbs
MSRP	\$8,163.50

#### BAD ASS MECHANIC CART - BA564830B

- (9) MotionLatch™ drawers  
-250 lbs load rating per drawer  
-heavy duty liner
- (2) full width MotionLatch™ top drawers
- Locking Drawers
- Heavy Duty push/pull handle
- 10" all terrain Bad Ass Casters, 2 swivel with Brakes, 2 fixed
- Built in D-Rings
- Flip Lid Top with Inverted Storage Tray
- Two-toned powder coat optional (pictured)



#### POWDER COAT COLORS:



\* ANY STANDARD PRODUCT CAN BE CUSTOMIZED TO YOUR SPECIFIC NEEDS, PLEASE CALL 715-355-8842 AND TALK TO YOUR CTECH REPRESENTATIVE TODAY. \*



SPECIFICATIONS:	BA-GRILL
WIDTH	48"
HEIGHT	37"- (Cart) 49"- (with grill)
DEPTH	30.5"
LOAD CAPACITY	250 lbs per drawer/shelf
DRAWERS	1-5", 1/8"
NET WEIGHT	357 lbs
MSRP	\$4,394.50

#### GRILL CART - BA-GRILL

- (2) MotionLatch™ drawers
  - 250 lbs load rating per drawer
  - heavy duty liner
- (3) MotionLatch™ door
- Adjust-A-Loc Shelves
- Propane Tank Storage (1 tank and 1 fire extinguisher)
- Vented Rear Panel
- Stainless Steel Top
- Heavy Duty push/pull handle
- 10" All Terrain bad ass casters, 2 swivel with Brakes, 2 fixed
- Bull Grill (designed to fit any standard 24" grill)



#### POWDER COAT COLORS:



\* ANY STANDARD PRODUCT CAN BE CUSTOMIZED TO YOUR SPECIFIC NEEDS, PLEASE CALL 715-355-8842 AND TALK TO YOUR CTECH REPRESENTATIVE TODAY. \*





<b>SPECIFICATIONS:</b>	<b>GEN5636A</b>
WIDTH	56"
HEIGHT	36"
DEPTH	30"
LOAD CAPACITY	250 lbs per drawer/shelf
DRAWERS	NA
NET WEIGHT	615 lbs
MSRP 5.5kw	\$9,179.50 (GEN5636A55)
MSRP 7.0kw	\$10,302.60 (GEN5636A7)

**GEN SET CART**

- (4) MotionLatch™ doors
- Remote Start/Stop Panel
- (4) 110V outlets, (1) 240V outlet (NEMA 4-30R)
- Vented Floor and Rear Panel
- Heavy Duty push/pull handle
- 10" all terrain Bad Ass Casters, 2 swivel with Brakes, 2 fixed
- Built in D-Rings
- Available in 5.5kW or 7.0kW
- 5.5kw Generator (operates at 67 dB) - Cummins Onan (4 cycle, OHV 90° V-Twin)
- 7kw Generator (operates at 67 dB) - Cummins Onan (4 cycle, OHV 90° V-Twin)

<b>SPECIFICATIONS:</b>	<b>GEN5649B</b>
WIDTH	56"
HEIGHT	48"
DEPTH	30"
LOAD CAPACITY	250 lbs per drawer/shelf
DRAWERS	2-3", 1-5"
NET WEIGHT	700 lbs
MSRP 5.5kw	\$10,851.50 (GEN5649B55)
MSRP 7.0kw	\$11,974.60 (GEN5649B7)

**GEN SET CART - STORAGE**

- (3) MotionLatch™ drawers  
-250 lbs load rating per drawer  
-heavy duty liner
- (7) MotionLatch™ doors
- Remote Start/Stop Panel
- (7) 110V outlets
- (2) 240V outlet (NEMA 4-30R)
- Vented Floor and Rear Panel
- Heavy Duty push/pull handle
- 10" all terrain Bad Ass Casters, 2 swivel with Brakes, 2 fixed
- Flip Lid Top with Inverted Storage Tray
- 10" All Terrain bad ass casters, 2 swivel with Brakes, 2 fixed
- Built in D-Rings
- 5.5kW Generator (operates at 67 dB) - Cummins Onan (4 cycle, OHV 90° V-Twin)
- 7kW Generator (operates at 67 dB) - Cummins Onan (4 cycle, OHV 90° V-Twin)



**POWDER COAT COLORS:**



\* ANY STANDARD PRODUCT CAN BE CUSTOMIZED TO YOUR SPECIFIC NEEDS, PLEASE CALL 715-355-8842 AND TALK TO YOUR CTECH REPRESENTATIVE TODAY. \*





# HOT ROD CARTS

Featuring the same Flat Free wheels with brakes as the Mini Cart CTech's Hot Rod Chassis gives a nostalgic feel with the addition of wrap around fenders and added effects to the chassis. Each one of the Hot Rod Carts has a special aspect to its design to set it apart from others. All MotionLatch™ drawers and shelves are equipped with heavy duty liner and rated for 250lbs. MotionLatch™ doors offers easy acces. Available in 12 standard powder coat colors.



## THE NAME SAYS IT ALL







SPECIFICATIONS:	HR-WAGON
WIDTH	26"
HEIGHT	14"
DEPTH	40"
LOAD CAPACITY	500 lbs
DRAWERS	NA
NET WEIGHT	75 lbs
MSRP	\$1,094.50

## HOT ROD CART - HR-WAGON

- Heavy Duty push/pull/steering T-handle
- 10" Flat Free Tires with Brakes

SPECIFICATIONS:	HR-FAN
WIDTH	46"
HEIGHT	44.875"
DEPTH	28.125"
LOAD CAPACITY	NA
DRAWERS	NA
NET WEIGHT	110 lbs
MSRP	\$1,864.50

## HOT ROD CART - HR-FAN

- Heavy Duty push/pull/steering T-handle
- 10" Flat Free Tires with Brakes
- Operates at 76 dB
- 1/2hp 2-stage motor
- Cubic ft per minute: 8180 or 18.52 MPR



SPECIFICATIONS:	HR-BD
WIDTH	36.5"
HEIGHT	52"
DEPTH	26"
LOAD CAPACITY	250 lbs per drawer/shelf
DRAWERS	2-3", 1-4", 1-8"
NET WEIGHT	261 lbs
MSRP	\$4,394.50

## BEST DAMN TOOLBOX - HR-BD

- (4) MotionLatch™ drawers  
-250 lbs load rating per drawer + heavy duty liner
- Heavy Duty push/pull/steering T-handle
- 10" Flat Free Tires with Brakes
- Built-in Mac's Tie-Down™ buttons
- Paper towel holder
- Oil can rack
- Zip tie holder
- Peg board surround
- Projack / EZ lift rack



## POWDER COAT COLORS:



\* ANY STANDARD PRODUCT CAN BE CUSTOMIZED TO YOUR SPECIFIC NEEDS, PLEASE CALL 715-355-8842 AND TALK TO YOUR CTECH REPRESENTATIVE TODAY. \*



# MINI CARTS



The Mini Cart chassis features Flat Free wheels with brakes. The one-sided nature of the mini cart design allows for ultimate storage in tight quarters. The chassis also allows for alternate storage possibilities through the series. All MotionLatch™ drawers and shelves are equipped with heavy duty liners and rated for 250lbs. MotionLatch™ doors offer easy access with a secure closure latched every time. Available in 12 standard powder coat colors, 6 standard configurations, and many customizable add-ons to make one all your own.





<b>SPECIFICATIONS:</b>	<b>MC403826A</b>
<b>WIDTH</b>	<b>40"</b>
<b>HEIGHT</b>	<b>38"</b>
<b>DEPTH</b>	<b>26"</b>
<b>LOAD CAPACITY</b>	<b>250 lbs per drawer/shelf</b>
<b>DRAWERS</b>	<b>NA</b>
<b>NET WEIGHT</b>	<b>223 lbs</b>
<b>MSRP</b>	<b>\$2,805.00</b>

#### MINI CART - MC403826A

- (2) MotionLatch™ doors
- Adjust-A-Loc Shelves
- Heavy Duty push/pull/steering T-handle
- 10" Flat Free Tires with Brakes
- Built in D-Rings

<b>SPECIFICATIONS:</b>	<b>MC403826B</b>
<b>WIDTH</b>	<b>40"</b>
<b>HEIGHT</b>	<b>38"</b>
<b>DEPTH</b>	<b>26"</b>
<b>LOAD CAPACITY</b>	<b>250 lbs per drawer/shelf</b>
<b>DRAWERS</b>	<b>2-3", 2-4", 1-6"</b>
<b>NET WEIGHT</b>	<b>341 lbs</b>
<b>MSRP</b>	<b>\$3,874.20</b>

#### MINI CART - MC403826B

- (5) MotionLatch™ drawers  
-250 lbs load rating per drawer + heavy duty liner
- Heavy Duty push/pull/steering T-handle
- Flip Lid Top with Inverted Storage Tray
- 10" Flat Free Tires with Brakes
- Built in D-Rings



<b>SPECIFICATIONS:</b>	<b>MC403826C</b>
<b>WIDTH</b>	<b>40"</b>
<b>HEIGHT</b>	<b>38"</b>
<b>DEPTH</b>	<b>26"</b>
<b>LOAD CAPACITY</b>	<b>250 lbs per drawer/shelf</b>
<b>DRAWERS</b>	<b>2-3", 2-4", 1-6"</b>
<b>NET WEIGHT</b>	<b>309 lbs</b>
<b>MSRP</b>	<b>\$3,404.50</b>

#### MINI CART - MC403826C

- (5) MotionLatch™ drawers  
-250 lbs load rating per drawer  
-heavy duty liner
- (1) MotionLatch™ doors
- Adjust-A-Loc Shelves
- Heavy Duty push/pull/steering T-handle
- 10" Flat Free Tires with Brakes
- Built in D-Rings



#### POWDER COAT COLORS:



\* ANY STANDARD PRODUCT CAN BE CUSTOMIZED TO YOUR SPECIFIC NEEDS, PLEASE CALL 715-355-8842 AND TALK TO YOUR CTECH REPRESENTATIVE TODAY. \*



SPECIFICATIONS:	MC403826D
WIDTH	40"
HEIGHT	38"
DEPTH	26"
LOAD CAPACITY	250 lbs per drawer/shelf
DRAWERS	2-3", 2-4", 1-6"
NET WEIGHT	324 lbs
MSRP	\$3,679.50

#### MINI CART - MC403826D

- (5) MotionLatch™ drawers  
-250 lbs load rating per drawer
- -heavy duty liner
- (1) MotionLatch™ doors
- Adjust-A-Loc Shelves
- Flip Lid Top with Inverted Storage Tray
- Heavy Duty push/pull/steering T-handle
- 10" Flat Free Tires with Brakes
- Built in D-Rings



#### POWDER COAT COLORS:

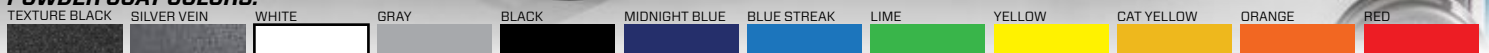

\* ANY STANDARD PRODUCT CAN BE CUSTOMIZED TO YOUR SPECIFIC NEEDS, PLEASE CALL 715-355-8842 AND TALK TO YOUR CTECH REPRESENTATIVE TODAY. \*





<b>SPECIFICATIONS:</b>	<b>MC403826E</b>
<b>WIDTH</b>	<b>40"</b>
<b>HEIGHT</b>	<b>38"</b>
<b>DEPTH</b>	<b>26"</b>
<b>LOAD CAPACITY</b>	<b>250 lbs per drawer/shelf</b>
<b>DRAWERS</b>	<b>1-4"</b>
<b>NET WEIGHT</b>	<b>245 lbs</b>
<b>MSRP</b>	<b>\$3,025.00</b>

#### MINI CART - MC403826E

- (1) MotionLatch™ drawers  
-250 lbs load rating per drawer  
-heavy duty liner
- (1) MotionLatch™ doors
- Adjust-A-Loc Shelves
- Heavy Duty push/pull/steering T-handle
- 10" Flat Free Tires with Brakes
- Built in D-Rings

<b>SPECIFICATIONS:</b>	<b>MC403826F</b>
<b>WIDTH</b>	<b>40"</b>
<b>HEIGHT</b>	<b>38"</b>
<b>DEPTH</b>	<b>26"</b>
<b>LOAD CAPACITY</b>	<b>250 lbs per drawer/shelf</b>
<b>DRAWERS</b>	<b>1-4"</b>
<b>NET WEIGHT</b>	<b>258 lbs</b>
<b>MSRP</b>	<b>\$3,300.00</b>

#### MINI CART - MC403826F

- (1) MotionLatch™ drawers  
-250 lbs load rating per drawer  
-heavy duty liner
- (1) MotionLatch™ doors
- Adjust-A-Loc Shelves
- Flip Lid Top with Inverted Storage Tray
- Heavy Duty push/pull/steering T-handle
- 10" Flat Free Tires with Brakes
- Built in D-Rings



#### POWDER COAT COLORS:



\* ANY STANDARD PRODUCT CAN BE CUSTOMIZED TO YOUR SPECIFIC NEEDS, PLEASE CALL 715-355-8842 AND TALK TO YOUR CTECH REPRESENTATIVE TODAY. \*



<b>SPECIFICATIONS:</b>	<b>MC673826A</b>
<b>WIDTH</b>	<b>67"</b>
<b>HEIGHT</b>	<b>38"</b>
<b>DEPTH</b>	<b>26"</b>
<b>LOAD CAPACITY</b>	<b>250 lbs per drawer/shelf</b>
<b>DRAWERS</b>	<b>2-3", 2-4", 1-6"</b>
<b>NET WEIGHT</b>	<b>388 lbs</b>
<b>MSRP</b>	<b>\$4,834.50</b>

**MINI CART - MC673826A**

- (5) MotionLatch™ drawers  
-250 lbs load rating per drawer  
-heavy duty liner
- (2) MotionLatch™ doors
- Adjust-A-Loc Shelves
- Heavy Duty push/pull/steering T-handle
- 10" Flat Free Tires with Brakes
- Built in D-Rings
- Chassis storage
- Nitrogen Bottle Cradle (chassis)



**NITROGEN STORAGE**

<b>SPECIFICATIONS:</b>	<b>MC673826B</b>
<b>WIDTH</b>	<b>67"</b>
<b>HEIGHT</b>	<b>38"</b>
<b>DEPTH</b>	<b>26"</b>
<b>LOAD CAPACITY</b>	<b>250 lbs per drawer/shelf</b>
<b>DRAWERS</b>	<b>2-3", 2-4", 1-6" X2</b>
<b>NET WEIGHT</b>	<b>497 lbs</b>
<b>MSRP</b>	<b>\$5,428.50</b>

**MINI CART - MC673826B**

- (10) MotionLatch™ drawers  
-250 lbs load rating per drawer  
-heavy duty liner
- Heavy Duty push/pull/steering T-handle
- 10" Flat Free Tires with Brakes
- Built in D-Rings
- Chassis storage
- Nitrogen Bottle Cradle (chassis)



**POWDER COAT COLORS:**



\* ANY STANDARD PRODUCT CAN BE CUSTOMIZED TO YOUR SPECIFIC NEEDS, PLEASE CALL 715-355-8842 AND TALK TO YOUR CTECH REPRESENTATIVE TODAY. \*



SPECIFICATIONS:	MC-GRILL
WIDTH	67"
HEIGHT	38"
DEPTH	26"
LOAD CAPACITY	250 lbs per drawer/shelf
DRAWERS	2-3", 2-4", 1-6"
NET WEIGHT	402 lbs
MSRP	\$6,594.50

## MINI CART - MC-GRILL

- (4) MotionLatch™ drawers  
-250 lbs load rating per drawer  
-heavy duty liner
- (2) MotionLatch™ doors
- Adjust-A-Loc Shelves
- Propane Tank Storage (1 tank and 1 fire extinguisher)
- Vented Rear Door
- Stainless Steel Top
- Flat Free Tires with Brakes
- Bull Grill (designed to fit any standard 24" grill)
- Heavy Duty push/pull/steering T-handle
- 10" Flat Free Tires with Brakes
- Built in D-Rings



## POWDER COAT COLORS:



\* ANY STANDARD PRODUCT CAN BE CUSTOMIZED TO YOUR SPECIFIC NEEDS, PLEASE CALL 715-355-8842 AND TALK TO YOUR CTECH REPRESENTATIVE TODAY. \*



# WORKTOP CARTS

The Work Top Cart is a 360° working experience with **DUAL SIDED** storage as well as chassis storage. The nature of the chassis allows for all types of add-on accessories lending this cart to be one of our most popular across many industries. All MotionLatch™ drawers and shelves are equipped with heavy duty liners and rated for 250lbs. MotionLatch™ doors offers easy access with a secure closure latched every time. Available in 12 standard powder coat colors.







<b>SPECIFICATIONS:</b>	<b>PC604236J</b>
<b>WIDTH</b>	<b>60"</b>
<b>HEIGHT</b>	<b>42"</b>
<b>DEPTH</b>	<b>36"</b>
<b>LOAD CAPACITY</b>	<b>250 lbs per drawer/shelf</b>
<b>DRAWERS</b>	<b>NA</b>
<b>NET WEIGHT</b>	<b>391 lbs</b>
<b>MSRP</b>	<b>\$4,757.50</b>

**WORK TOP CART - PC604236J**

- (6) MotionLatch™ doors
- (3) MotionLatch™ doors (chassis)
- Adjust-A-Loc Shelves
- Dual-sided storage
- Heavy Duty push/pull/steering T-handle
- 16" Pneumatic Tires - Optional Hydraulic Brakes
- Built in D-Rings



REVERSE SIDE



<b>SPECIFICATIONS:</b>	<b>PC604236K</b>
<b>WIDTH</b>	<b>60"</b>
<b>HEIGHT</b>	<b>42"</b>
<b>DEPTH</b>	<b>36"</b>
<b>LOAD CAPACITY</b>	<b>250 lbs per drawer/shelf</b>
<b>DRAWERS</b>	<b>2-3", 3-4", 2-6"</b>
<b>NET WEIGHT</b>	<b>514 lbs</b>
<b>MSRP</b>	<b>\$5,494.50</b>

**WORK TOP CART - PC604236K**

- (7) MotionLatch™ drawers  
-250 lbs load rating per drawer  
-heavy duty liner
- (5) MotionLatch™ doors
- Adjust-A-Loc Shelves
- (2) MotionLatch™ doors (chassis)
- Dual-sided storage
- Heavy Duty push/pull/steering T-handle
- 16" Pneumatic Tires
- Optional Hydraulic Brakes
- Built in D-Rings



REVERSE SIDE



**POWDER COAT COLORS:**



\* ANY STANDARD PRODUCT CAN BE CUSTOMIZED TO YOUR SPECIFIC NEEDS, PLEASE CALL 715-355-8842 AND TALK TO YOUR CTECH REPRESENTATIVE TODAY. \*



<b>SPECIFICATIONS:</b>	<b>PC724236H</b>
<b>WIDTH</b>	<b>72"</b>
<b>HEIGHT</b>	<b>42"</b>
<b>DEPTH</b>	<b>36"</b>
<b>LOAD CAPACITY</b>	<b>250 lbs per drawer/shelf</b>
<b>DRAWERS</b>	<b>2-3", 3-4"</b>
<b>NET WEIGHT</b>	<b>503 lbs</b>
<b>MSRP</b>	<b>\$5,604.50</b>



- WORK TOP CART - PC724236H**
- (5) MotionLatch™ drawers  
-250 lbs load rating per drawer  
-heavy duty liner
  - (5) MotionLatch™ doors
  - Adjust-A-Loc Shelves
  - (3) MotionLatch™ doors (chassis)
  - Dual-sided storage
  - Heavy Duty push/pull/steering T-handle
  - 16" Pneumatic Tires
  - Optional Hydraulic Brakes
  - Built in D-Rings



REVERSE SIDE

<b>SPECIFICATIONS:</b>	<b>PC724236L</b>
<b>WIDTH</b>	<b>72"</b>
<b>HEIGHT</b>	<b>42"</b>
<b>DEPTH</b>	<b>36"</b>
<b>LOAD CAPACITY</b>	<b>250 lbs per drawer/shelf</b>
<b>DRAWERS</b>	<b>2-3", 3-4"</b>
<b>NET WEIGHT</b>	<b>523 lbs</b>
<b>MSRP</b>	<b>\$5,890.50</b>



- WORK TOP CART - PC724236HN - Nitrogen Cradle**
- (5) MotionLatch™ drawers  
-250 lbs load rating per drawer  
-heavy duty liner
  - (5) MotionLatch™ doors
  - Adjust-A-Loc Shelves
  - (3) MotionLatch™ doors (chassis)
  - Dual-sided storage
  - Heavy Duty push/pull/steering T-handle
  - 16" Pneumatic Tires
  - Optional Hydraulic Brakes
  - Built in D-Rings
  - Nitrogen Bottle Cradle (chassis)



REVERSE SIDE  
**NITROGEN STORAGE**

**POWDER COAT COLORS:**



\* ANY STANDARD PRODUCT CAN BE CUSTOMIZED TO YOUR SPECIFIC NEEDS, PLEASE CALL 715-355-8842 AND TALK TO YOUR CTECH REPRESENTATIVE TODAY. \*





<b>SPECIFICATIONS:</b>	<b>PC724236M</b>
<b>WIDTH</b>	<b>72"</b>
<b>HEIGHT</b>	<b>42"</b>
<b>DEPTH</b>	<b>36"</b>
<b>LOAD CAPACITY</b>	<b>250 lbs per drawer/shelf</b>
<b>DRAWERS</b>	<b>4-3", 6-4"</b>
<b>NET WEIGHT</b>	<b>622 lbs</b>
<b>MSRP</b>	<b>\$6,678.10</b>

**WORK TOP CART - PC724236MN - Nitrogen Cradle**

- (10) MotionLatch™ drawers  
-250 lbs load rating per drawer  
-heavy duty liner
- (4) MotionLatch™ doors
- Adjust-A-Loc Shelves
- (3) MotionLatch™ doors (chassis)
- Dual-sided storage
- Heavy Duty push/pull/steering T-handle
- 16" Pneumatic Tires
- Optional Hydraulic Brakes
- Built in D-Rings
- Nitrogen Bottle Cradle (chassis)



REVERSE SIDE

**NITROGEN STORAGE**

**POWDER COAT COLORS:**



\* ANY STANDARD PRODUCT CAN BE CUSTOMIZED TO YOUR SPECIFIC NEEDS, PLEASE CALL 715-355-8842 AND TALK TO YOUR CTECH REPRESENTATIVE TODAY. \*





# PRO SERIES CARTS



All Pro Series carts offer dual-sided storage and chassis storage, while the Crew Chief cart features an additional option to enclose that work surface. The design of the cart opens it to an array of add-on accessories making it very popular in the racing industry. All MotionLatch™ drawers and shelves are equipped with heavy duty liners and are rated for 250lbs. MotionLatch™ doors offer easy access storage. Available in 12 standard powder coat colors, many standard configurations, and many customizable add-ons to make one all your own.





<b>SPECIFICATIONS:</b>	<b>PC606736E</b>
<b>WIDTH</b>	<b>60"</b>
<b>HEIGHT</b>	<b>67"</b>
<b>DEPTH</b>	<b>36"</b>
<b>LOAD CAPACITY</b>	<b>250 lbs per drawer/shelf</b>
<b>DRAWERS</b>	<b>2-3", 1-4", 1-5", 1-6"</b>
<b>NET WEIGHT</b>	<b>576 lbs</b>
<b>MSRP</b>	<b>\$6,264.50</b> *

**CREW CHIEF CART - PC606736E**

- (5) MotionLatch™ drawers  
-250 lbs load rating per drawer  
-heavy duty liner
- (8) MotionLatch™ doors
- Adjust-A-Loc Shelves
- (4) MotionLatch™ doors (chassis)
- Dual-sided storage
- Enclosed Work Surface with Flip Up Trigger Latch Door
- Heavy Duty push/pull/steering T-handle
- 16" Pneumatic Tires
- Optional Hydraulic Brakes
- Built in D-Rings
- Nitrogen Bottle Cradle (chassis)



REVERSE SIDE

\* shown with optional door

<b>SPECIFICATIONS:</b>	<b>PC726736F</b>
<b>WIDTH</b>	<b>72"</b>
<b>HEIGHT</b>	<b>67"</b>
<b>DEPTH</b>	<b>36"</b>
<b>LOAD CAPACITY</b>	<b>250 lbs per drawer/shelf</b>
<b>DRAWERS</b>	<b>2-3", 1-4", 1-5", 1-6"</b>
<b>NET WEIGHT</b>	<b>637 lbs</b>
<b>MSRP</b>	<b>\$7,034.50</b> *

**CREW CHIEF CART - PC726736F**

- (5) MotionLatch™ drawers  
-250 lbs load rating per drawer  
-heavy duty liner
- (8) MotionLatch™ doors
- Adjust-A-Loc Shelves
- (4) MotionLatch™ doors (chassis)
- Dual-sided storage
- Enclosed Work Surface with Flip Up Trigger Latch Door
- Heavy Duty push/pull/steering T-handle
- 16" Pneumatic Tires
- Optional Hydraulic Brakes
- Built in D-Rings
- Nitrogen Bottle Cradle (chassis)



**NITROGEN STORAGE**



REVERSE SIDE

\* shown with optional door

**POWDER COAT COLORS:**



\* ANY STANDARD PRODUCT CAN BE CUSTOMIZED TO YOUR SPECIFIC NEEDS, PLEASE CALL 715-355-8842 AND TALK TO YOUR CTECH REPRESENTATIVE TODAY. \*



<b>SPECIFICATIONS:</b>	<b>PC726736G</b>
<b>WIDTH</b>	<b>72"</b>
<b>HEIGHT</b>	<b>67"</b>
<b>DEPTH</b>	<b>36"</b>
<b>LOAD CAPACITY</b>	<b>250 lbs per drawer/shelf</b>
<b>DRAWERS</b>	<b>3X - 3-4", 1-8"</b>
<b>NET WEIGHT</b>	<b>754 lbs</b>
<b>MSRP</b>	<b>\$9,894.50</b>



**SPORTSMAN CART - PC726736G - Nitrogen Cradle**

- (12) MotionLatch™ drawers  
-250 lbs load rating per drawer  
-heavy duty liner
- (9) MotionLatch™ doors
- Adjust-A-Loc Shelves
- (3) MotionLatch™ doors (chassis)
- Dual-sided storage
- (3) Nitrogen Bottle Cradle (upper)
- (1) Nitrogen Bottle Cradle (chassis)
- Heavy Duty push/pull/steering T-handle
- Pneumatic Tires
- Optional Hydraulic Brakes
- Built in D-Rings

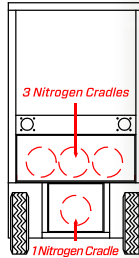

REVERSE SIDE

<b>SPECIFICATIONS:</b>	<b>PC966736A</b>
<b>WIDTH</b>	<b>96"</b>
<b>HEIGHT</b>	<b>67"</b>
<b>DEPTH</b>	<b>36"</b>
<b>LOAD CAPACITY</b>	<b>250 lbs per drawer/shelf</b>
<b>DRAWERS</b>	<b>3X - 3-4", 1-8"</b>
<b>NET WEIGHT</b>	<b>861 lbs</b>
<b>MSRP</b>	<b>\$14,294.50</b>



**SPORTSMAN CART - PC966736A - Nitrogen Cradle**

- (12) MotionLatch™ drawers  
-250 lbs load rating per drawer  
-heavy duty liner
- (10) MotionLatch™ doors
- Adjust-A-Loc Shelves
- (5) MotionLatch™ doors (chassis)
- Dual-sided storage
- (3) Nitrogen Bottle Cradle (upper)
- (1) Nitrogen Bottle Cradle (chassis)
- Heavy Duty push/pull/steering T-handle
- Pneumatic Tires
- Optional Hydraulic Brakes
- Built in D-Rings



REVERSE SIDE

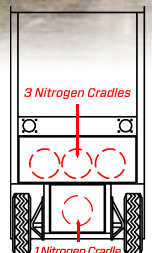

**POWDER COAT COLORS:**



\* ANY STANDARD PRODUCT CAN BE CUSTOMIZED TO YOUR SPECIFIC NEEDS, PLEASE CALL 715-355-8842 AND TALK TO YOUR CTECH REPRESENTATIVE TODAY. \*





<b>SPECIFICATIONS:</b>	<b>PC967242C</b>
<b>WIDTH</b>	<b>96"</b>
<b>HEIGHT</b>	<b>72"</b>
<b>DEPTH</b>	<b>42"</b>
<b>LOAD CAPACITY</b>	<b>250 lbs per drawer/shelf</b>
<b>DRAWERS</b>	<b>3X - 1-3", 2-4", 2-5", 1-6"</b>
<b>NET WEIGHT</b>	<b>1027 lbs</b>
<b>MSRP</b>	<b>\$14,850.00</b>



**SPORTSMAN CART - PC967242C - Nitrogen Cradle**

- (18) MotionLatch™ drawers  
-250 lbs load rating per drawer  
-heavy duty liner
- (7) MotionLatch™ doors
- Adjust-A-Loc Shelves
- (5) MotionLatch™ doors (chassis)
- Dual-sided storage
- (2) Nitrogen Bottle Cradle (chassis)
- Ship-To-Shore Power Inlet
- Lights and Outlets in 18" deep workspace
- Heavy Duty push/pull/steering T-handle
- Pneumatic Tires
- Optional Hydraulic Brakes
- Built in D-Rings



REVERSE SIDE

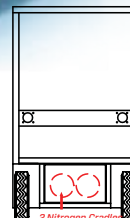

<b>SPECIFICATIONS:</b>	<b>PC1207036D</b>
<b>WIDTH</b>	<b>120"</b>
<b>HEIGHT</b>	<b>70"</b>
<b>DEPTH</b>	<b>36"</b>
<b>LOAD CAPACITY</b>	<b>250 lbs per drawer/shelf</b>
<b>DRAWERS</b>	<b>3X - 2-3", 1-4", 1-6", 1-8"</b>
<b>NET WEIGHT</b>	<b>1122 lbs</b>
<b>MSRP</b>	<b>\$18,694.50</b>

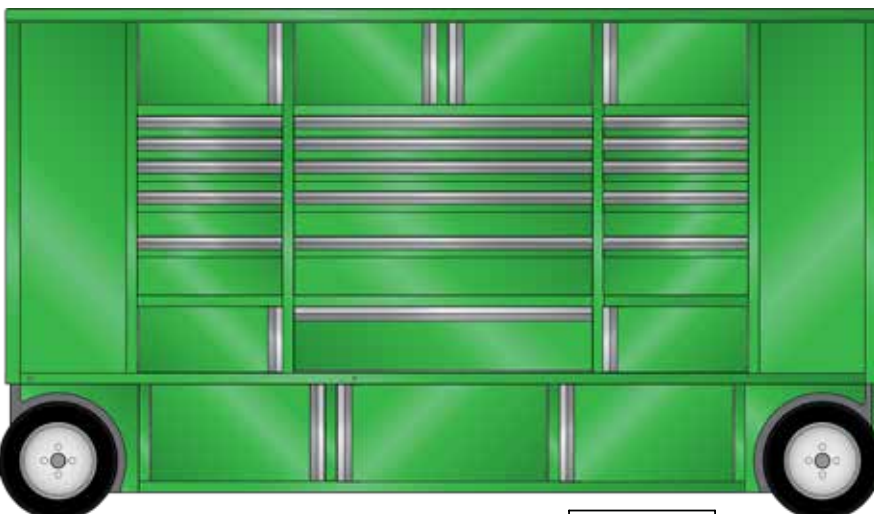

**SPORTSMAN CART - PC1207036D - Nitrogen Cradle**

- (15) MotionLatch™ drawers  
-250 lbs load rating per drawer  
-heavy duty liner
- (14) MotionLatch™ doors (cart)
- Adjust-A-Loc Shelves
- (7) MotionLatch™ doors (chassis)
- Dual-sided storage
- Flip Down Work Bench
- (3) Nitrogen Bottle Cradle (upper)
- (1) Nitrogen Bottle Cradle (chassis)
- Heavy Duty push/pull/steering T-handle
- Pneumatic Tires
- Optional Hydraulic Brakes
- Built in D-Rings



REVERSE SIDE

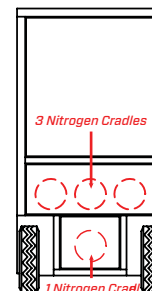

**POWDER COAT COLORS:**



\* ANY STANDARD PRODUCT CAN BE CUSTOMIZED TO YOUR SPECIFIC NEEDS, PLEASE CALL 715-355-8842 AND TALK TO YOUR CTECH REPRESENTATIVE TODAY. \*

# CART OPTIONS

\* ANY STANDARD PRODUCT CAN BE CUSTOMIZED TO YOUR SPECIFIC NEEDS, PLEASE CALL 715-355-8842 AND TALK TO YOUR CTECH REPRESENTATIVE TODAY. \*

## TIE-DOWNS:



Removable Tie-Down Hooks



Built in D-Rings



Billet Aluminum D-Rings

## PUSH/PULL HANDLES:



No handle  
- Service, Caster, Bad Ass Caster



Fold Away Handle  
- Service, Caster, Bad Ass Caster

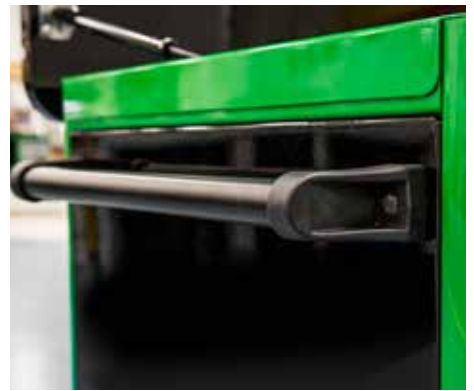

Heavy Duty Push / Pull Handle  
- Service, Caster, Bad Ass Caster



T-Handle  
- Hot Rod, Mini, Work Top & Pro



Heim Joint  
- Hot Rod, Mini, Work Top & Pro



Pintle Hook  
- Service, Caster, Bad Ass Caster



TOP OPTIONS:



Fixed Top (DA sanded, or powder coated)

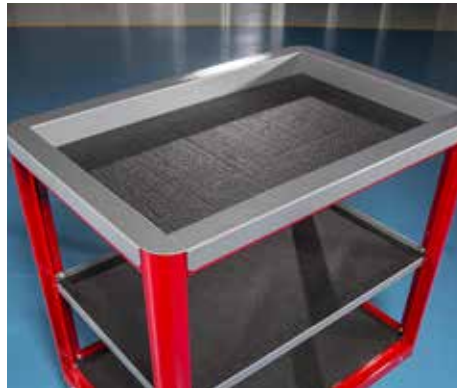

Inverted Top



Flip Lid

TOP ADD ONS:

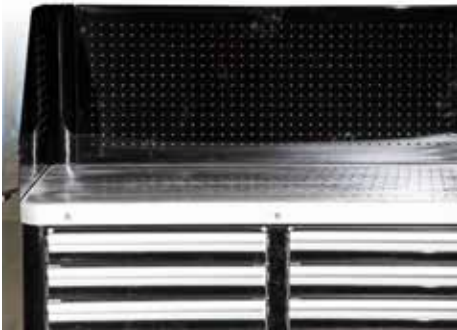

Peg Board Surround



Back Splash



Liner Top Cover



Stainless Steel Overlay



1/4" UHMW Overlay



Butcher Block



Removable Tire Rack

POWER OPTIONS:



Ship-To-Shore Power  
- weather resilient mobile power inlet



Electrical Reel



Pre-Wired Options  
- HDMI, USB, RCA, and Power

PLUMBING OPTIONS:



Air Hose Reel



Regulators



Integrated Air Compressor

ADDITIONAL OPTIONS:



Nitrogen Cradles



Cart Stabilizers



Overhead Storage



Receiver Vise Insert



Vent Panel, Door, or Floor



Sink Insert



Charging Station



Monitor Doors



Observation Deck Seating



ADDITIONAL OPTIONS:



Bench Cushion



Injection Molded Display Components



Removable Exterior Shelving



End Panel Door and Tag Board



Hydraulic Disc Brakes



Cart Cover



Race Day Canopy



Display Rack and Shelving



Canopy Monitor Mount







CTech is no stranger to pit row at any event. CORE Autosports has an attractive pit setup utilizing a Jr. Transporter and Fuel Cart for their race day storage needs.

## RACING CARTS

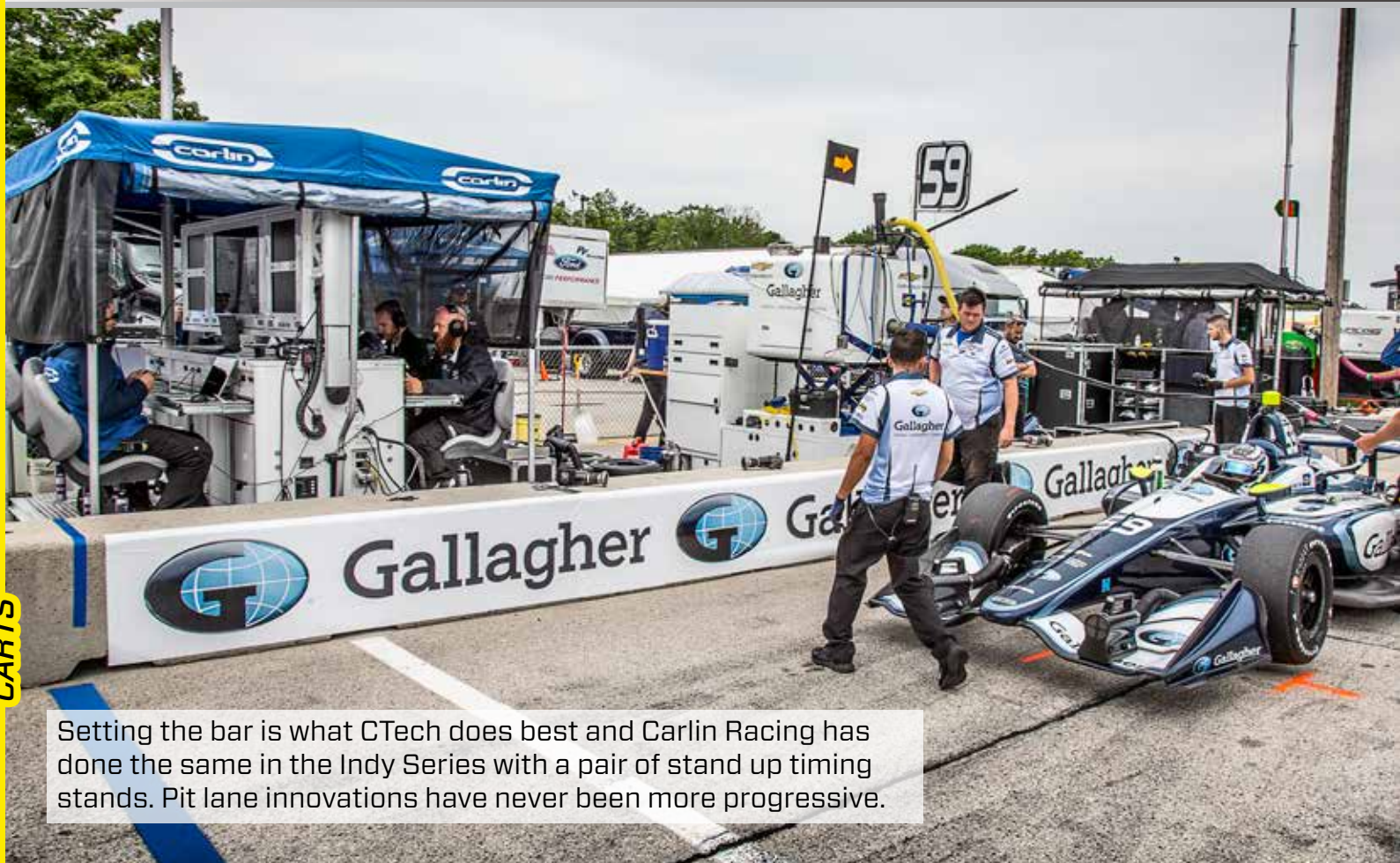

Setting the bar is what CTech does best and Carlin Racing has done the same in the Indy Series with a pair of stand up timing stands. Pit lane innovations have never been more progressive.





Twin Platforms offer a great collaborative deck area for 2 car teams. BMW USA has a beautiful pit lane presence.

**THE ONLY 120" TRANSPORTABLE OBSERVATION CART WITH A REAR DECK THAT FITS IN THE AISLE OF YOUR TRAILER!**



WeatherTech and Scuderia Corsa demand a professional pit row, in appearance, as well as function, which is why they choose CTech as their storage solution!



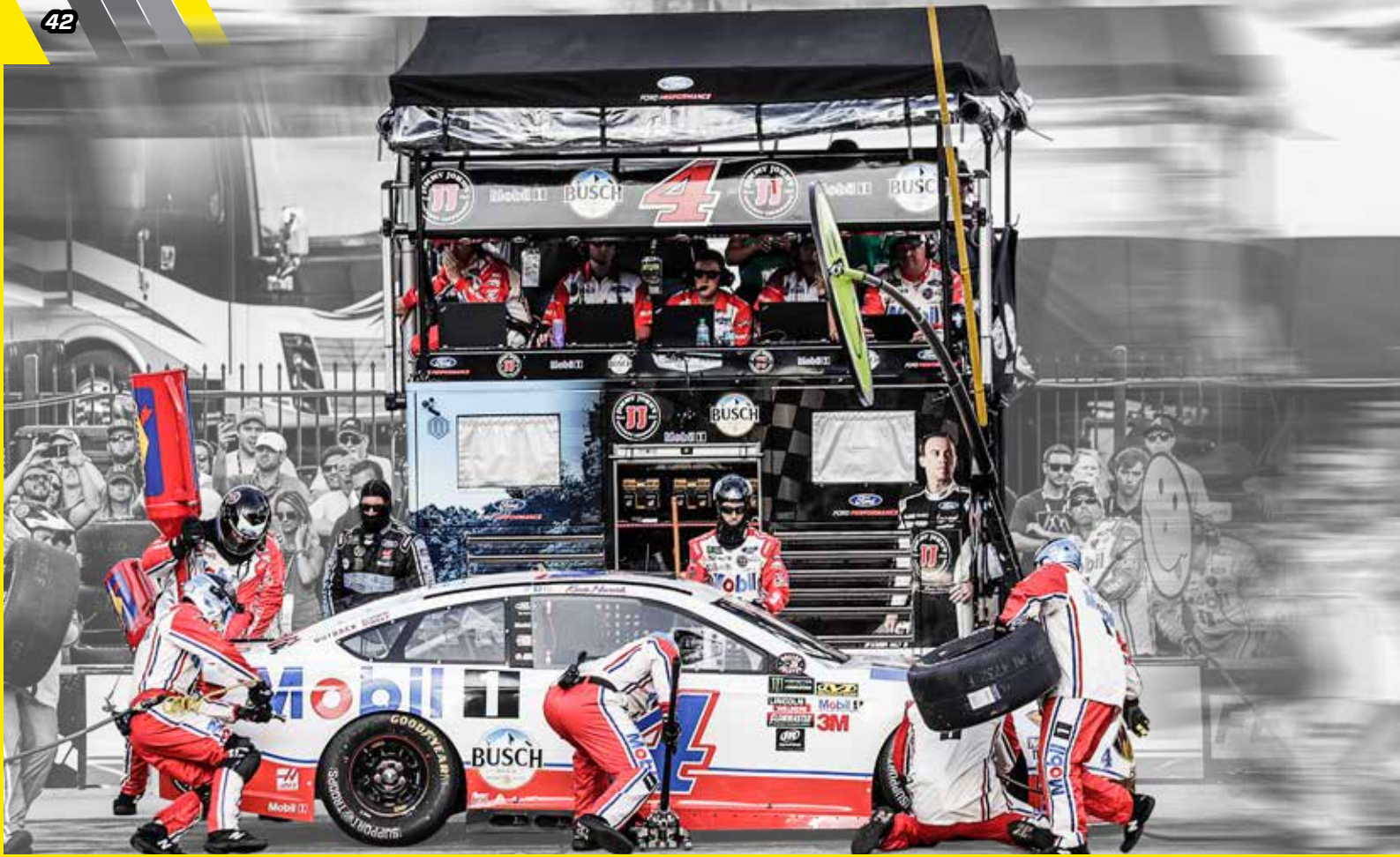

# DECK CARTS

- **Motorsports**
- **Entertainment**
- **Owners Deck**
- **Media Coverage**
- **Hospitality**



*The possibilities*





**2019 NASCAR XFINITY - CTech Manufacturing 180 @ Road America**

The CTech car took the pole and led most of the race!  
Team Kaulig Racing and driver AJ Allmendinger did a great job.



- Construction
- Oil Field
- Industrial
- Military
- Engineering Support

**CARTS**

*are endless...*





Digital communication carts designed for sideline communication for a National Sporting League. Built on a Mini Cart and Bad Ass Caster Cart chassis.

# INDUSTRIAL CARTS



Mobile workstations built on the Hot Rod chassis. These carts are designed to the customer's specifications for storage with electrical pre-wired and MotionLatch™ adjustable shelves.



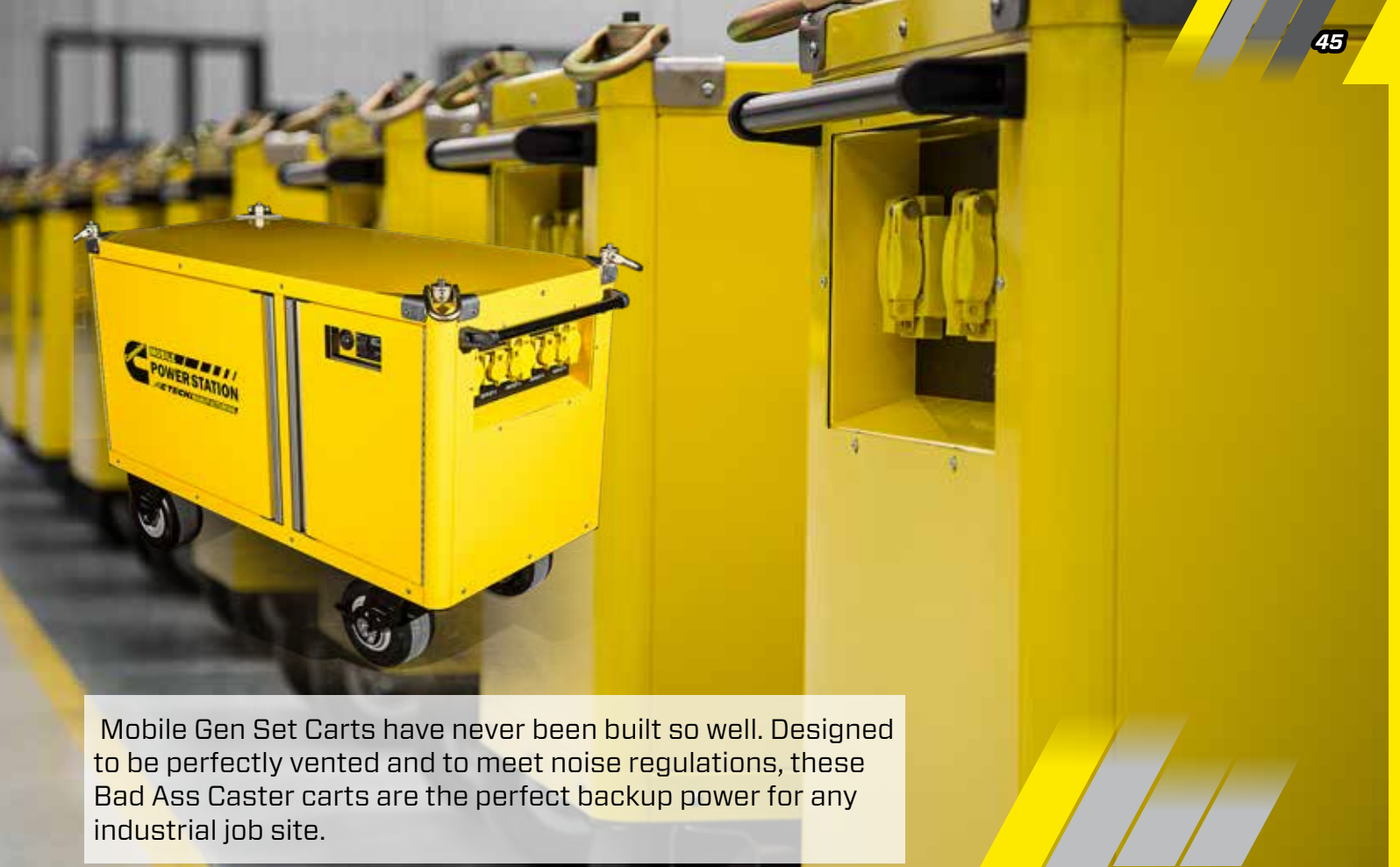

Mobile Gen Set Carts have never been built so well. Designed to be perfectly vented and to meet noise regulations, these Bad Ass Caster carts are the perfect backup power for any industrial job site.



Outfitting a lab with workstations similar to these at North Central Technical College provide the mobility of a cart and the work area of a counter. These also add extra storage space for an organized and efficient environment.



***AUTOMOTIVE***



***BUSINESS & MARKETING***



***CONSTRUCTION***





# MILITARY / DEFENSE



# EDUCATION



# PROFESSIONAL SPORTS



*AEROSPACE*



*INDUSTRIAL*



*GRAPHICS / PRINTING*





*RETAIL*



*FACILITIES MANAGEMENT*



*MOTORSPORTS*





# PREMIUM

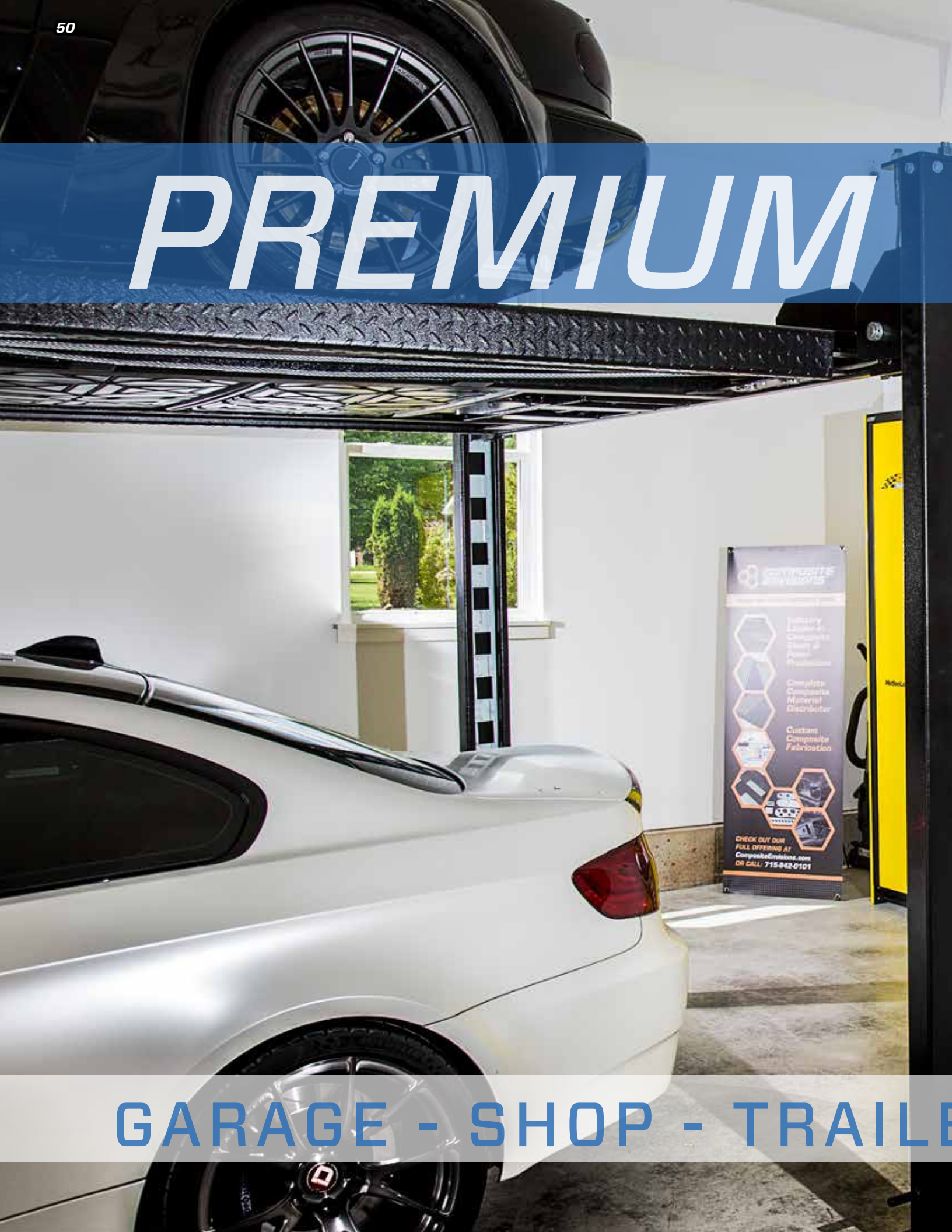

# GARAGE - SHOP - TRAILER



# CABINETS



ER - SPECIALTY VEHICLE

**Gas Shock Stays**

- Overhead cabinets use gas shock stays.

**Extruded Aluminum Frame**

- Lightweight aluminum cabinet frame is pound-for-pound stronger than most steel alloys.

**Body Panels**

- Tough powder coat aluminum double walled doors for strength and rigidity. 0.090" extrusions 0.080" body panels 0.080" drawer body

**GasketLoc Counter top \***

- Spill proof countertop. Easily replaced counter and reusable guard gasket.

**MotionLatch™ Drawers \***

- ONE HAND - ONE MOTION opening function lets you grab anywhere on the extruded aluminum handle and effortlessly open our 250lb rated drawers.

**Adjust-A-Loc \***

- Internal adjustable cabinet shelving in 2" increments and locking shelf clips.



**5052**  
ALUMINUM  
BODY PANELS

EXTRUDED  
ALUMINUM FRAME



**RADIUS  
CORNERS**  
FASTENER ASSEMBLED

FEATURES WITH (\*) CAN BE SEEN IN THE EXPANDED FEATURE DESCRIPTIONS ON THE FOLLOWING PAGES



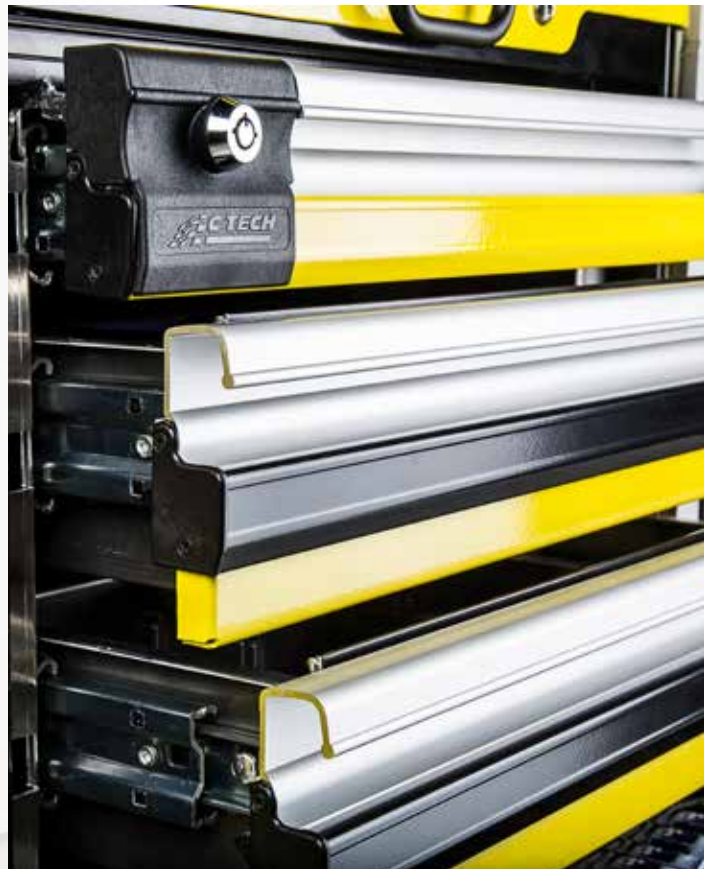

Engineered with strong aluminum extrusions

**INDUSTRY FIRST!**

**MOTIONLATCH™ DRAWERS & DOORS**

- Offers a ONE HAND - ONE MOTION operation even with a handful of tools
- No pinching, no squeezing, no twisting, just pull the handle and the latches release
- MotionLatch™ opening function lets you grab anywhere on the extruded aluminum handle and effortlessly open our 250lb rated drawers



Dual composite latches stay closed

**CTECH EXCLUSIVE**  
**MotionLatch™**  
**Drawer & Door System**  
 US Patent 6,547,289



## **GasketLoc** CTECH EXCLUSIVE Countertop System



Gasket in counter top prevents fluids from leaking into cabinet

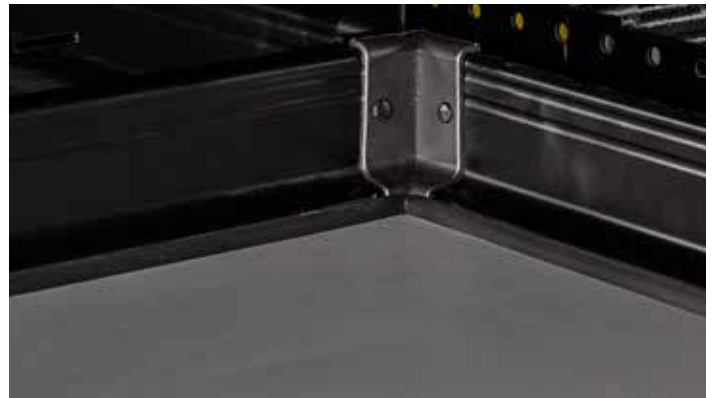

Injection molded corner fittings

### **GASKETLOC COUNTERTOP**

- *Designed to allow the countertop to expand and contract to prevent warping*
- *Injection-molded corners no sharp edges*
- *2<sup>1</sup>/<sub>4</sub>" High back and side splashes*
- *Screws or caulk NOT required*
- *Replaceable countertop*
- *Keep fluids from leaking into your cabinet*
- *Available in 2 surfaces:*
  1. *Gray Laminate (standard)*
  2. *Stainless Steel*





Internal bracing shelf adjustment

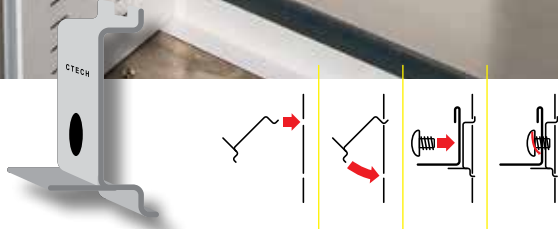

## ADJUST-A-LOC SHELVING

- Precision formed and hemmed from a single sheet of 0.080" aluminum
- Exclusively designed shelf clips and wall slots are engineered to stay tight
- The Adjust-A-Loc™ shelving becomes an integral component of the cabinet
- Shelving comes standard in mill finish. Upgrades include padded non-skid liners and/or powder coat finish



Adjust-A-Loc MotionLatch™ pull out shelves

# ECONO SERIES



CTech is known for premium aluminum cabinets designed for trailers, shops, and garages. The features and benefits associated with CTech cabinets are what set our quality apart; MotionLatch™ drawers and doors, extruded aluminum framework, lightweight construction, GasketLoc countertops, dual walled doors, etc. Our Econo Series cabinets have all those features at an entry level cost. These packages are perfect for any garage or trailer. Available in a pre-finished white aluminum versus our traditional powder coat finish is where you save.







<b>SPECIFICATIONS:</b>	<b>ECONO1</b>
<b>WIDTH</b>	<b>72"</b>
<b>HEIGHT</b>	<b>75"</b>
<b>DEPTH</b>	<b>24"</b>
<b>LOAD CAPACITY</b>	<i>250 lbs per shelf</i>
<b>DRAWERS</b>	<b>NA</b>
<b>NET WEIGHT</b>	<b>154lbs</b>
<b>MSRP</b>	<b>\$1250.00</b>



**ECONO SERIES - Econo1**

- EC0721614 Overhead 72w x 16h x 14d
- ECBA723624 Base 72w x 38.25h x 24d
- GasketLoc Countertop - 36h
- MotionLatch Doors
- Adjust-A-Loc Shelves



<b>SPECIFICATIONS:</b>	<b>ECONO2</b>
<b>WIDTH</b>	<b>72"</b>
<b>HEIGHT</b>	<b>75"</b>
<b>DEPTH</b>	<b>24"</b>
<b>LOAD CAPACITY</b>	<i>250 lbs per drawer/shelf</i>
<b>DRAWERS</b>	<b>1-5", 1-6", 1-10", 1-12"</b>
<b>NET WEIGHT</b>	<b>189lbs</b>
<b>MSRP</b>	<b>\$1900.00</b>

**ECONO SERIES - Econo2**

- EC0721614 Overhead 72w x 16h x 14d
- ECBB723624 Base 72w x 38.5h x 24d
- GasketLoc Countertop - 36h
- MotionLatch Doors
- MotionLatch Drawers
- Adjust-A-Loc Shelves





<b>SPECIFICATIONS:</b>	<b>ECONO3</b>
<b>WIDTH</b>	<b>94"</b>
<b>HEIGHT</b>	<b>75"</b>
<b>DEPTH</b>	<b>24"</b>
<b>LOAD CAPACITY</b>	<b>250 lbs per shelf</b>
<b>DRAWERS</b>	<b>NA</b>
<b>NET WEIGHT</b>	<b>208lbs</b>
<b>MSRP</b>	<b>\$1800.00</b>

#### **ECONO SERIES - Econo3**

- EC0721614 Overhead 72w x 16h x 14d
- ECBA723624 Base 72w x 38.25h x 24d
- ECC752422 Closet 22w x 75h x 24d
- GasketLoc Countertop - 36h
- MotionLatch Doors
- Adjust-A-Loc Shelves
- Hanger Bar



<b>SPECIFICATIONS:</b>	<b>ECONO4</b>
<b>WIDTH</b>	<b>94"</b>
<b>HEIGHT</b>	<b>75"</b>
<b>DEPTH</b>	<b>24"</b>
<b>LOAD CAPACITY</b>	<b>250 lbs per drawer/ shelf</b>
<b>DRAWERS</b>	<b>1-5", 1-6", 1-10", 1-12"</b>
<b>NET WEIGHT</b>	<b>243lbs</b>
<b>MSRP</b>	<b>\$2450.00</b>

#### **ECONO SERIES - Econo4**

- EC0721614 Overhead 72w x 16h x 14d
- ECBB723624 Base 72w x 38.25h x 24d
- ECC752422 Closet 22w x 75h x 24d
- GasketLoc Countertop - 36h
- MotionLatch Doors
- MotionLatch Drawers
- Adjust-A-Loc Shelves
- Hanger Bar





OVERHEAD - ECO481614  
48w x 16h x 14d

Opening 1: 21.75w x 13h: Top Swing  
Opening 2: 21.75w x 13h: Top Swing

MotionLatch Doors

45 lbs

**\$324.50**



OVERHEAD - ECO721614  
72w x 16h x 14d

Opening 1: 33.75w x 13h: Top Swing  
Opening 2: 33.75w x 13h: Top Swing

MotionLatch Doors

53 lbs

**\$471.90**



CLOSET - ECC752422  
22w x 75h x 24d

Opening 1: 19w x 69h: Left Swing

MotionLatch Doors  
Adjust-A-Loc Shelves  
Hanger Bar

54 lbs

**\$581.90**



WALL - ECW362416  
36w x 24h x 16d

Opening 1: 15.75w x 21h: Left Swing  
Opening 2: 15.75w x 21h: Right Swing

MotionLatch Doors  
Adjust-A-Loc Shelves

45 lbs

**\$405.90**



WALL - ECW482416  
48w x 24h x 16d

Opening 1: 21.75w x 21h: Left Swing  
Opening 2: 21.75w x 21h: Right Swing

MotionLatch Doors  
Adjust-A-Loc Shelves

49 lbs

**\$493.90**



BASE - ECBA723624  
72w x 38.25h x 24d

Opening 1: 22w x 34h: Left Swing  
Opening 2: 22w x 34h: Left Swing  
Opening 3: 22w x 34h: Right Swing

GasketLoc Countertop - 36h  
MotionLatch Doors  
Adjust-A-Loc Shelves

101 lbs

**\$856.90**



BASE - ECBB723624  
72w x 38.5h x 24d

Opening 1: 22w x 34h: Left Swing  
Opening 2: 22w x 34h: Drawers: 5, 6, 10, 12  
Opening 3: 22w x 34h: Right Swing

GasketLoc Countertop - 36h  
MotionLatch Doors  
MotionLatch Drawers  
Adjust-A-Loc Shelves

136 lbs

**\$1534.50**



# PRO SERIES



Pro Series or P-Series cabinets are the product that launched the CTech brand and set the new standards to mobile and stationary storage throughout the industry. The product is continually being improved upon but the core has stayed relatively unchanged since its beginning.





<b>SPECIFICATIONS:</b>	<b>P1000</b>
<b>WIDTH</b>	<b>96"</b>
<b>HEIGHT</b>	<b>75"</b>
<b>DEPTH</b>	<b>26"</b>
<b>LOAD CAPACITY</b>	<b>250 lbs per shelf</b>
<b>DRAWERS</b>	<b>NA</b>
<b>NET WEIGHT</b>	<b>210lbs</b>
<b>MSRP</b>	<b>\$3050.00</b>

**PRO SERIES - P1000**

- 03-96 Overhead 96w x 14h x 14d
- B3-96 Base 96w x 42.25h x 26d
- GasketLoc Countertop - 40h
- MotionLatch Doors
- Adjust-A-Loc Shelves

<b>SPECIFICATIONS:</b>	<b>P1001</b>
<b>WIDTH</b>	<b>96"</b>
<b>HEIGHT</b>	<b>75"</b>
<b>DEPTH</b>	<b>26"</b>
<b>LOAD CAPACITY</b>	<b>250 lbs per shelf</b>
<b>DRAWERS</b>	<b>3-3"</b>
<b>NET WEIGHT</b>	<b>258lbs</b>
<b>MSRP</b>	<b>\$3750.00</b>

**PRO SERIES - P1001**

- 03-96 Overhead 96w x 14h x 14d
- BC3-96 Base 96w x 42.25h x 26d
- GasketLoc Countertop - 40h
- MotionLatch Doors
- MotionLatch Drawers
- Adjust-A-Loc Shelves



<b>SPECIFICATIONS:</b>	<b>P1002</b>
<b>WIDTH</b>	<b>96"</b>
<b>HEIGHT</b>	<b>75"</b>
<b>DEPTH</b>	<b>26"</b>
<b>LOAD CAPACITY</b>	<b>250 lbs per shelf</b>
<b>DRAWERS</b>	<b>1-3", 4-4", 3-6"</b>
<b>NET WEIGHT</b>	<b>335lbs</b>
<b>MSRP</b>	<b>\$4500.00</b>

**PRO SERIES - P1002**

- 03-96 Overhead 96w x 14h x 14d
- BD3-96 Base 96w x 42.25h x 26d
- GasketLoc Countertop - 40h
- MotionLatch Doors
- MotionLatch Drawers
- Adjust-A-Loc Shelves



**POWDER COAT COLORS:**



\* ANY STANDARD PRODUCT CAN BE CUSTOMIZED TO YOUR SPECIFIC NEEDS, PLEASE CALL 715-355-8842 AND TALK TO YOUR CTECH REPRESENTATIVE TODAY. \*



<b>SPECIFICATIONS:</b>	<b>P1003</b>
<b>WIDTH</b>	<b>96"</b>
<b>HEIGHT</b>	<b>75"</b>
<b>DEPTH</b>	<b>26"</b>
<b>LOAD CAPACITY</b>	<b>250 lbs per shelf</b>
<b>DRAWERS</b>	<b>NA</b>
<b>NET WEIGHT</b>	<b>218lbs</b>
<b>MSRP</b>	<b>\$3325.00</b>

**PRO SERIES - P1003**

- O2-72 Overhead 72w x 14h x 14d
- B2-72 Base 72w x 42.25h x 26d
- C1-24L Closet 24w x 75h x 26d
- GasketLoc Countertop - 40h
- MotionLatch Doors
- Adjust-A-Loc Shelves
- Hanger Bar

<b>SPECIFICATIONS:</b>	<b>P1004</b>
<b>WIDTH</b>	<b>96"</b>
<b>HEIGHT</b>	<b>75"</b>
<b>DEPTH</b>	<b>26"</b>
<b>LOAD CAPACITY</b>	<b>250 lbs per shelf</b>
<b>DRAWERS</b>	<b>2-3"</b>
<b>NET WEIGHT</b>	<b>252lbs</b>
<b>MSRP</b>	<b>\$3825.00</b>

**PRO SERIES - P1004**

- O2-72 Overhead 72w x 14h x 14d
- BC2-72 Base 72w x 42.25h x 26d
- C1-24L Closet 24w x 75h x 26d
- GasketLoc Countertop - 40h
- MotionLatch Doors
- MotionLatch Drawers
- Adjust-A-Loc Shelves
- Hanger Bar



<b>SPECIFICATIONS:</b>	<b>P1005</b>
<b>WIDTH</b>	<b>96"</b>
<b>HEIGHT</b>	<b>75"</b>
<b>DEPTH</b>	<b>26"</b>
<b>LOAD CAPACITY</b>	<b>250 lbs per shelf</b>
<b>DRAWERS</b>	<b>1-3", 4-4", 3-6"</b>
<b>NET WEIGHT</b>	<b>332lbs</b>
<b>MSRP</b>	<b>\$4875.00</b>

**PRO SERIES - P1005**

- O2-72 Overhead 72w x 14h x 14d
- BD2-72 Base 72w x 42.25h x 26d
- C1-24L Closet 24w x 75h x 26d
- GasketLoc Countertop - 40h
- MotionLatch Doors
- MotionLatch Drawers
- Adjust-A-Loc Shelves
- Hanger Bar

**POWDER COAT COLORS:**

\* ANY STANDARD PRODUCT CAN BE CUSTOMIZED TO YOUR SPECIFIC NEEDS, PLEASE CALL 715-355-8842 AND TALK TO YOUR CTECH REPRESENTATIVE TODAY. \*



<b>SPECIFICATIONS:</b>	<b>P1006</b>
<b>WIDTH</b>	<b>96"</b>
<b>HEIGHT</b>	<b>75"</b>
<b>DEPTH</b>	<b>26"</b>
<b>LOAD CAPACITY</b>	<b>250 lbs per shelf</b>
<b>DRAWERS</b>	<b>3-3"</b>
<b>NET WEIGHT</b>	<b>247lbs</b>
<b>MSRP</b>	<b>\$3525.00</b>

**PRO SERIES - P1006**

- O2-72 Overhead 72w x 14h x 14d
- B3-72 Base 72w x 42.25h x 26d
- C1-24L Closet 24w x 75h x 26d
- GasketLoc Countertop - 40h
- MotionLatch Doors
- Adjust-A-Loc Shelves
- Hanger Bar



<b>SPECIFICATIONS:</b>	<b>P1007</b>
<b>WIDTH</b>	<b>96"</b>
<b>HEIGHT</b>	<b>75"</b>
<b>DEPTH</b>	<b>26"</b>
<b>LOAD CAPACITY</b>	<b>250 lbs per shelf</b>
<b>DRAWERS</b>	<b>3-3"</b>
<b>NET WEIGHT</b>	<b>287lbs</b>
<b>MSRP</b>	<b>\$4150.00</b>

**PRO SERIES - P1007**

- O2-72 Overhead 72w x 14h x 14d
- BC3-72 Base 72w x 42.25h x 26d
- C1-24L Closet 24w x 75h x 26d
- GasketLoc Countertop - 40h
- MotionLatch Doors
- MotionLatch Drawers
- Adjust-A-Loc Shelves
- Hanger Bar



<b>SPECIFICATIONS:</b>	<b>P1008</b>
<b>WIDTH</b>	<b>96"</b>
<b>HEIGHT</b>	<b>75"</b>
<b>DEPTH</b>	<b>26"</b>
<b>LOAD CAPACITY</b>	<b>250 lbs per shelf</b>
<b>DRAWERS</b>	<b>1-3", 4-4", 3-6"</b>
<b>NET WEIGHT</b>	<b>352lbs</b>
<b>MSRP</b>	<b>\$4775.00</b>

**PRO SERIES - P1008**

- O2-72 Overhead 72w x 14h x 14d
- BD3-72 Base 72w x 42.25h x 26d
- C1-24L Closet 24w x 75h x 26d
- GasketLoc Countertop - 40h
- MotionLatch Doors
- MotionLatch Drawers
- Adjust-A-Loc Shelves
- Hanger Bar



**POWDER COAT COLORS:**



\* ANY STANDARD PRODUCT CAN BE CUSTOMIZED TO YOUR SPECIFIC NEEDS, PLEASE CALL 715-355-8842 AND TALK TO YOUR CTECH REPRESENTATIVE TODAY. \*



<b>SPECIFICATIONS:</b>	<b>P1009</b>
<b>WIDTH</b>	<b>96"</b>
<b>HEIGHT</b>	<b>75"</b>
<b>DEPTH</b>	<b>48"</b>
<b>LOAD CAPACITY</b>	<b>250 lbs per shelf</b>
<b>DRAWERS</b>	<b>NA</b>
<b>NET WEIGHT</b>	<b>220lbs</b>
<b>MSRP</b>	<b>\$3225.00</b>

**PRO SERIES - P1009**

- O3-96 Overhead 96w x 14h x 14d
- LB2-96 Corner Base 96w x 42.25h x 48d
- GasketLoc Countertop - 40h
- MotionLatch Doors
- Adjust-A-Loc Shelves

<b>SPECIFICATIONS:</b>	<b>P1011</b>
<b>WIDTH</b>	<b>96"</b>
<b>HEIGHT</b>	<b>75"</b>
<b>DEPTH</b>	<b>48"</b>
<b>LOAD CAPACITY</b>	<b>250 lbs per shelf</b>
<b>DRAWERS</b>	<b>2-3"</b>
<b>NET WEIGHT</b>	<b>250lbs</b>
<b>MSRP</b>	<b>\$3725.00</b>

**PRO SERIES - P1011**

- O3-96 Overhead 96w x 14h x 14d
- LBC2-96 Corner Base 96w x 42.25h x 48d
- GasketLoc Countertop - 40h
- MotionLatch Doors
- MotionLatch Drawers
- Adjust-A-Loc Shelves



<b>SPECIFICATIONS:</b>	<b>P1013</b>
<b>WIDTH</b>	<b>96"</b>
<b>HEIGHT</b>	<b>75"</b>
<b>DEPTH</b>	<b>48"</b>
<b>LOAD CAPACITY</b>	<b>250 lbs per shelf</b>
<b>DRAWERS</b>	<b>1-3", 4-4", 3-6"</b>
<b>NET WEIGHT</b>	<b>450lbs</b>
<b>MSRP</b>	<b>\$4775.00</b>

**PRO SERIES - P1013**

- O3-96 Overhead 96w x 14h x 14d
- LBD2-96 Corner Base 96w x 42.25h x 28d
- GasketLoc Countertop - 40h
- MotionLatch Doors
- MotionLatch Drawers
- Adjust-A-Loc Shelves



*All corner packages are available in right corner configurations as well*

**POWDER COAT COLORS:**

\* ANY STANDARD PRODUCT CAN BE CUSTOMIZED TO YOUR SPECIFIC NEEDS, PLEASE CALL 715-355-8842 AND TALK TO YOUR CTECH REPRESENTATIVE TODAY. \*



<b>SPECIFICATIONS:</b>	<b>P1015</b>
<b>WIDTH</b>	<b>96"</b>
<b>HEIGHT</b>	<b>75"</b>
<b>DEPTH</b>	<b>48"</b>
<b>LOAD CAPACITY</b>	<b>250 lbs per shelf</b>
<b>DRAWERS</b>	<b>3-3"</b>
<b>NET WEIGHT</b>	<b>235lbs</b>
<b>MSRP</b>	<b>\$3400.00</b>

**PRO SERIES - P1015**

- O3-96 Overhead 96w x 14h x 14d
- LB3-96 Corner Base 96w x 42.25h x 48d
- GasketLoc Countertop - 40h
- MotionLatch Doors
- Adjust-A-Loc Shelves



<b>SPECIFICATIONS:</b>	<b>P1017</b>
<b>WIDTH</b>	<b>96"</b>
<b>HEIGHT</b>	<b>75"</b>
<b>DEPTH</b>	<b>48"</b>
<b>LOAD CAPACITY</b>	<b>250 lbs per drawer/shelf</b>
<b>DRAWERS</b>	<b>3-3"</b>
<b>NET WEIGHT</b>	<b>270lbs</b>
<b>MSRP</b>	<b>\$4025.00</b>

**PRO SERIES - P1017**

- O3-96 Overhead 96w x 14h x 14d
- LBC3-96 Corner Base 96w x 42.25h x 48d
- GasketLoc Countertop - 40h
- MotionLatch Doors
- MotionLatch Drawers
- Adjust-A-Loc Shelves



<b>SPECIFICATIONS:</b>	<b>P1019</b>
<b>WIDTH</b>	<b>96"</b>
<b>HEIGHT</b>	<b>75"</b>
<b>DEPTH</b>	<b>48"</b>
<b>LOAD CAPACITY</b>	<b>250 lbs per shelf</b>
<b>DRAWERS</b>	<b>1-3", 4-4", 3-6"</b>
<b>NET WEIGHT</b>	<b>340lbs</b>
<b>MSRP</b>	<b>\$4650.00</b>

**PRO SERIES - P1019**

- O3-96 Overhead 96w x 14h x 14d
- LBD3-96 Corner Base 96w x 42.25h x 48d
- GasketLoc Countertop - 40h
- MotionLatch Doors
- MotionLatch Drawers
- Adjust-A-Loc Shelves



All corner packages are available in right corner configurations as well

**POWDER COAT COLORS:**



\* ANY STANDARD PRODUCT CAN BE CUSTOMIZED TO YOUR SPECIFIC NEEDS, PLEASE CALL 715-355-8842 AND TALK TO YOUR CTECH REPRESENTATIVE TODAY. \*



<b>SPECIFICATIONS:</b>	<b>P1021</b>
<b>WIDTH</b>	<b>96"</b>
<b>HEIGHT</b>	<b>75"</b>
<b>DEPTH</b>	<b>48"</b>
<b>LOAD CAPACITY</b>	<b>250 lbs per shelf</b>
<b>DRAWERS</b>	<b>NA</b>
<b>NET WEIGHT</b>	<b>257lbs</b>
<b>MSRP</b>	<b>\$3675.00</b>

**PRO SERIES - P1021**

- O2-72 Overhead 72w x 14h x 14d
- LB2-72 Corner Base 72w x 42.25h x 48d
- C1-24R Closet 24w x 75h x 26d
- GasketLoc Countertop - 40h
- MotionLatch Doors
- Adjust-A-Loc Shelves
- Hanger Bar

<b>SPECIFICATIONS:</b>	<b>P1023</b>
<b>WIDTH</b>	<b>96"</b>
<b>HEIGHT</b>	<b>75"</b>
<b>DEPTH</b>	<b>48"</b>
<b>LOAD CAPACITY</b>	<b>250 lbs per shelf</b>
<b>DRAWERS</b>	<b>2-3"</b>
<b>NET WEIGHT</b>	<b>282lbs</b>
<b>MSRP</b>	<b>\$4100.00</b>

**PRO SERIES - P1023**

- O2-72 Overhead 72w x 14h x 14d
- LBC2-72 Corner Base 72w x 42.25h x 48d
- C1-24R Closet 24w x 75h x 26d
- GasketLoc Countertop - 40h
- MotionLatch Doors
- MotionLatch Drawers
- Adjust-A-Loc Shelves
- Hanger Bar



<b>SPECIFICATIONS:</b>	<b>P1025</b>
<b>WIDTH</b>	<b>96"</b>
<b>HEIGHT</b>	<b>75"</b>
<b>DEPTH</b>	<b>48"</b>
<b>LOAD CAPACITY</b>	<b>250 lbs per shelf</b>
<b>DRAWERS</b>	<b>1-3", 4-4", 3-6"</b>
<b>NET WEIGHT</b>	<b>357lbs</b>
<b>MSRP</b>	<b>\$4950.00</b>

**PRO SERIES - P1025**

- O2-72 Overhead 72w x 14h x 14d
- LBD2-72 Corner Base 72w x 42.25h x 48d
- C1-24R Closet 24w x 75h x 26d
- GasketLoc Countertop - 40h
- MotionLatch Doors
- MotionLatch Drawers
- Adjust-A-Loc Shelves
- Hanger Bar



All corner packages are available in right corner configurations as well

**POWDER COAT COLORS:**



\* ANY STANDARD PRODUCT CAN BE CUSTOMIZED TO YOUR SPECIFIC NEEDS, PLEASE CALL 715-355-8842 AND TALK TO YOUR CTECH REPRESENTATIVE TODAY. \*





OVERHEAD - 02-60  
60w x 14h x 14d

Opening 1: 27.75w x 11h: Top Swing  
Opening 2: 27.75w x 11h: Top Swing

MotionLatch Doors  
26 lbs

**\$615.58**



OVERHEAD - 02-72  
72w x 14h x 14d

Opening 1: 33.75w x 11h: Top Swing  
Opening 2: 33.75w x 11h: Top Swing

MotionLatch Doors  
31 lbs

**\$694.63**

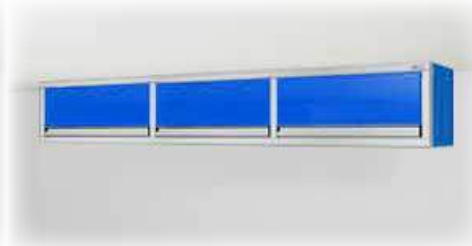

OVERHEAD - 03-96  
96w x 14h x 14d

Opening 1: 30w x 11h: Top Swing  
Opening 2: 30w x 11h: Top Swing  
Opening 3: 30w x 11h: Top Swing

MotionLatch Doors  
40 lbs

**\$948.46**



WALL - W2-48  
48w x 16h x 14d

Opening 1: 21.75w x 13h: Left Swing  
Opening 2: 21.75w x 13h: Right Swing

MotionLatch Doors  
21 lbs

**\$402.02**



WALL - W4-96  
96w x 16h x 14d

Opening 1: 22.125w x 13h: Left Swing  
Opening 2: 22.125w x 13h: Right Swing  
Opening 3: 22.125w x 13h: Left Swing  
Opening 4: 22.125w x 13h: Right Swing

MotionLatch Doors  
58 lbs

**\$768.46**



BASE - B2-60  
60w x 40h x 26d

Opening 1: 27.75w x 38h: Left Swing  
Opening 2: 27.75w x 38h: Right Swing

GasketLoc Countertop  
MotionLatch Doors  
GasketLoc Countertops add 2.25" to any  
base cabinet overall height  
110 lbs

**\$1517.13**



BASE - B2-72  
72w x 42.25h x 26d

Opening 1: 33.75w x 38h: Left Swing  
Opening 2: 33.75w x 38h: Right Swing

GasketLoc Countertop - 40h  
MotionLatch Doors  
Adjust-A-Loc Shelves

126 lbs

**\$1705.87**



BASE - BC2-60  
60w x 42.25h x 26d

Opening 1: 27.75w x 4.125h: Drawers: 4  
Opening 2: 27.75w x 33.875h: Left Swing  
Opening 3: 27.75w x 4.125h: Drawers: 4  
Opening 4: 27.75w x 33.875h: Right Swing

GasketLoc Countertop - 40h  
MotionLatch Doors  
MotionLatch Drawers  
Adjust-A-Loc Shelves

145 lbs

**\$2003.54**



BASE - BC2-72  
72w x 42.25h x 26d

Opening 1: 33.75w x 4.125h: Drawers: 4  
Opening 2: 33.75w x 33.875h: Left Swing  
Opening 3: 33.75w x 4.125h: Drawers: 4  
Opening 4: 33.75w x 33.875h: Right Swing

GasketLoc Countertop - 40h  
MotionLatch Doors  
MotionLatch Drawers  
Adjust-A-Loc Shelves

160 lbs

**\$2232.35**

**POWDER COAT COLORS:**



\* ANY STANDARD PRODUCT CAN BE CUSTOMIZED TO YOUR SPECIFIC NEEDS, PLEASE CALL 715-355-8842 AND TALK TO YOUR CTECH REPRESENTATIVE TODAY. \*



BASE - BD2-60  
60w x 42.25h x 26d

Opening 1: 27.75w x 38h: Left Swing  
Opening 2: 27.75w x 38h: Drawers: 3, 4, 4, 4, 4, 6, 6, 6

GasketLoc Countertop - 40h  
MotionLatch Doors  
MotionLatch Drawers  
Adjust-A-Loc Shelves

225 lbs

**\$2995.18**



BASE - BD2-72  
72w x 42.25h x 26d

Opening 1: 33.75w x 38h: Left Swing  
Opening 2: 33.75w x 38h: Drawers: 3, 4, 4, 4, 4, 6, 6, 6

GasketLoc Countertop - 40h  
MotionLatch Doors  
MotionLatch Drawers  
Adjust-A-Loc Shelves

250 lbs

**\$3338.45**



BASE - B3-72  
72w x 42.25h x 26d

Opening 1: 22w x 38h: Left Swing  
Opening 2: 22w x 38h: Left Swing  
Opening 3: 22w x 38h: Right Swing

GasketLoc Countertop - 40h  
MotionLatch Doors  
Adjust-A-Loc Shelves

140 lbs

**\$1893.08**



BASE - B3-96  
96w x 42.25h x 26d

Opening 1: 30w x 38h: Left Swing  
Opening 2: 30w x 38h: Left Swing  
Opening 3: 30w x 38h: Right Swing

GasketLoc Countertop - 40h  
MotionLatch Doors  
Adjust-A-Loc Shelves

170 lbs

**\$2270.56**



BASE - BC3-72  
72w x 42.25h x 26d

Opening 1: 22w x 4.125h: Drawers: 4 inch  
Opening 2: 22w x 33.875h: Left Swing  
Opening 3: 22w x 4.125h: Drawers: 4 inch  
Opening 4: 22w x 33.875h: Left Swing  
Opening 5: 22w x 4.125h: Drawers: 4 inch  
Opening 6: 22w x 33.875h: Left Swing

GasketLoc Countertop - 40h  
MotionLatch Doors  
MotionLatch Drawers  
Adjust-A-Loc Shelves

180 lbs

**\$2565.09**



BASE - BC3-96  
96w x 42.25h x 26d

Opening 1: 30w x 4.125h: Drawers: 4 inch  
Opening 2: 30w x 33.875h: Left Swing  
Opening 3: 30w x 4.125h: Drawers: 4 inch  
Opening 4: 30w x 33.875h: Left Swing  
Opening 5: 30w x 4.125h: Drawers: 4 inch  
Opening 6: 30w x 33.875h: Right Swing

GasketLoc Countertop - 40h  
MotionLatch Doors  
MotionLatch Drawers  
Adjust-A-Loc Shelves

218 lbs

**\$3022.72**



BASE - BD3-72  
72w x 42.25h x 26d

Opening 1: 22w x 38h: Left Swing  
Opening 2: 22w x 38h: Left Swing  
Opening 3: 22w x 38h: Drawers: 3, 4, 4, 4, 4, 6, 6, 6

GasketLoc Countertop - 40h  
MotionLatch Doors  
MotionLatch Drawers  
Adjust-A-Loc Shelves

245 lbs

**\$3223.05**



BASE - BD3-96  
96w x 42.25h x 26d

Opening 1: 30w x 38h: Left Swing  
Opening 2: 30w x 38h: Left Swing  
Opening 3: 30w x 38h: Drawers: 3, 4, 4, 4, 4, 6, 6, 6

GasketLoc Countertop - 40h  
MotionLatch Doors  
MotionLatch Drawers  
Adjust-A-Loc Shelves

295 lbs

**\$3806.56**



CORNER BASE - LB2-72 & RB2-72  
Overall: 72w x 42.25h x 48d  
Main: 72w x 42.25h x 26d  
Leg: 48w x 42.25h x 24d

Opening 1: 19w x 38h: Right Swing  
Opening 2: 21.75w x 38h: Left Swing  
Opening 3: 21.75w x 38h: Right Swing

GasketLoc Countertop - 40h  
MotionLatch Doors  
Adjust-A-Loc Shelves

150 lbs

**\$2071.27**

**POWDER COAT COLORS:**



\* ANY STANDARD PRODUCT CAN BE CUSTOMIZED TO YOUR SPECIFIC NEEDS, PLEASE CALL 715-355-8842 AND TALK TO YOUR CTECH REPRESENTATIVE TODAY. \*





**CORNER BASE - LB2-96 & RB2-96**  
 Overall: 96w x 42.25h x 48d  
 Main: 96w x 42.25h x 26d  
 Leg: 48w x 42.25h x 24d

Opening 1: 19w x 38h: Right Swing  
 Opening 2: 33.75w x 38h: Left Swing  
 Opening 3: 33.75w x 38h: Right Swing

GasketLoc Countertop - 40h  
 MotionLatch Doors  
 Adjust-A-Loc Shelves

180 lbs

**\$2448.75**



**CORNER BASE - LBC2-72 & RB2-72**  
 Overall: 72w x 42.25h x 48d  
 Main: 72w x 42.25h x 26d  
 Leg: 48w x 42.25h x 24d

Opening 1: 19w x 38h: Right Swing  
 Opening 2: 21.75w x 4.125h: Drawers: 4  
 Opening 3: 21.75w x 33.875h: Left Swing  
 Opening 4: 21.75w x 4.125h: Drawers: 4  
 Opening 5: 21.75w x 33.875h: Right Swing

GasketLoc Countertop - 40h  
 MotionLatch Doors  
 MotionLatch Drawers  
 Adjust-A-Loc Shelves

175 lbs

**\$2517.60**



**CORNER BASE - LBC2-96 & RBC2-96**  
 Overall: 96w x 42.25h x 48d  
 Main: 96w x 42.25h x 26d  
 Leg: 48w x 42.25h x 24d

Opening 1: 19w x 38h: Right Swing  
 Opening 2: 33.75w x 4.125h: Drawers: 4  
 Opening 3: 33.75w x 33.875h: Left Swing  
 Opening 4: 33.75w x 4.125h: Drawers: 4  
 Opening 5: 33.75w x 33.875h: Right Swing

GasketLoc Countertop - 40h  
 MotionLatch Doors  
 MotionLatch Drawers  
 Adjust-A-Loc Shelves

210 lbs

**\$2975.23**



**CORNER BASE - LBD2-72 & RBD2-72**  
 Overall: 72w x 42.25h x 48d  
 Main: 72w x 42.25h x 26d  
 Leg: 48w x 42.25h x 24d

Opening 1: 19w x 38h: Right Swing  
 Opening 2: 21.75w x 38h: Left Swing  
 Opening 3: Drawers: 3, 4, 4, 4, 6, 6, 6

GasketLoc Countertop - 40h  
 MotionLatch Doors  
 MotionLatch Drawers  
 Adjust-A-Loc Shelves

250 lbs

**\$3394.80**



**CORNER BASE - LBD2-96 & RBD2-96**  
 Overall: 96w x 42.25h x 48d  
 Main: 96w x 42.25h x 26d  
 Leg: 48w x 42.25h x 24d

Opening 1: 19w x 38h: Right Swing  
 Opening 2: 33.75w x 38h: Left Swing  
 Opening 3: Drawers: 3, 4, 4, 4, 6, 6, 6

GasketLoc Countertop - 40h  
 MotionLatch Doors  
 MotionLatch Drawers  
 Adjust-A-Loc Shelves

410 lbs

**\$4081.33**



**CORNER BASE - LB3-96 & RB3-96**  
 Overall: 96w x 42.25h x 48d  
 Main: 96w x 42.25h x 26d  
 Leg: 48w x 42.25h x 24d

Opening 1: 19w x 38h: Right Swing  
 Opening 2: 22w x 38h: Left Swing  
 Opening 3: 22w x 38h: Left Swing  
 Opening 4: 22w x 38h: Right Swing

GasketLoc Countertop - 40h  
 MotionLatch Doors  
 Adjust-A-Loc Shelves

195 lbs

**\$2635.96**



**CORNER BASE - LBC3-96 & RBC3-96**  
 Overall: 96w x 42.25h x 48d  
 Main: 96w x 42.25h x 26d  
 Leg: 48w x 42.25h x 24d

Opening 1: 19w x 38h: Right Swing  
 Opening 2: 22w x 4.125h: Drawers: 4 inch  
 Opening 3: 22w x 33.875h: Left Swing  
 Opening 4: 22w x 4.125h: Drawers: 4 inch  
 Opening 5: 22w x 33.875h: Left Swing  
 Opening 6: 22w x 4.125h: Drawers: 4 inch  
 Opening 7: 22w x 33.875h: Right Swing

GasketLoc Countertop - 40h  
 MotionLatch Doors  
 MotionLatch Drawers  
 Adjust-A-Loc Shelves

250 lbs

**\$3307.97**



**CORNER BASE - LBD3-96 & RBD3-96**  
 Overall: 96w x 42.25h x 48d  
 Main: 96w x 42.25h x 26d  
 Leg: 48w x 42.25h x 24d

Opening 1: 19w x 38h: Right Swing  
 Opening 2: 22w x 38h: Left Swing  
 Opening 3: 22w x 38h: Left Swing  
 Opening 4: Drawers: 3, 4, 4, 4, 6, 6, 6

GasketLoc Countertop - 40h  
 MotionLatch Doors  
 MotionLatch Drawers  
 Adjust-A-Loc Shelves

300 lbs

**\$3965.93**



**CLOSET - C1-24L & C1-24R**  
 24w x 75h x 26d

Opening 1: 21w x 72h: Left Swing

MotionLatch Doors  
 Adjust-A-Loc Shelves  
 Hanger Bar

76 lbs

**\$1124.58**

**POWDER COAT COLORS:**



\* ANY STANDARD PRODUCT CAN BE CUSTOMIZED TO YOUR SPECIFIC NEEDS, PLEASE CALL 715-355-8842 AND TALK TO YOUR CTECH REPRESENTATIVE TODAY. \*

# ULTRA SERIES



Taking premium to the next level with the ULTRA Series. Designed with all the added accessories; radius corners, LED lighting, adjustable toe kick, and much more. These cabinets transform any environment into the ultimate storage showcase with radius corners, powder coat finish, optional LED lighting, 2 tone color combinations, and pull out MotionLatch™ shelves. Perfect for any garage, shop or showroom.







<b>SPECIFICATIONS:</b>	<b>MILWAUKEE</b>
<b>WIDTH</b>	<b>88"</b>
<b>HEIGHT</b>	<b>85"</b>
<b>DEPTH</b>	<b>26"</b>
<b>LOAD CAPACITY</b>	<b>250 lbs per drawer/shelf</b>
<b>DRAWERS</b>	<b>2-4"</b>
<b>NET WEIGHT</b>	<b>280lbs</b>
<b>MSRP</b>	<b>\$4550.00</b>

**ULTRA SERIES - MILWAUKEE**

- GW3-88 Wall 88w x 24h x 16d
- GBC37-88 Base 88w x 42.75h x 24d
- GasketLoc Countertop - 40.5
- MotionLatch Doors
- MotionLatch Drawers
- Heavy-Duty Drawer Liner
- Adjust-A-Loc Shelves
- Heavy-Duty Shelf Liner
- Snag-Free Radius Corners
- Adjustable Toe Kick

<b>SPECIFICATIONS:</b>	<b>BAJA</b>
<b>WIDTH</b>	<b>88"</b>
<b>HEIGHT</b>	<b>85"</b>
<b>DEPTH</b>	<b>26"</b>
<b>LOAD CAPACITY</b>	<b>250 lbs per drawer/shelf</b>
<b>DRAWERS</b>	<b>5-4", 2-6", 1-9"</b>
<b>NET WEIGHT</b>	<b>394lbs</b>
<b>MSRP</b>	<b>\$5825.00</b>

**ULTRA SERIES - BAJA**

- GW3-88 Wall 88w x 24h x 16d
- GBCD-88 Base 88w x 42.75h x 24d
- GasketLoc Countertop - 40.5
- MotionLatch Doors
- MotionLatch Drawers
- Heavy-Duty Drawer Liner
- Adjust-A-Loc Shelves
- Heavy-Duty Shelf Liner
- Snag-Free Radius Corners
- Adjustable Toe Kick



<b>SPECIFICATIONS:</b>	<b>BRISTOL</b>
<b>WIDTH</b>	<b>144"</b>
<b>HEIGHT</b>	<b>85"</b>
<b>DEPTH</b>	<b>26"</b>
<b>LOAD CAPACITY</b>	<b>250 lbs per drawer/shelf</b>
<b>DRAWERS</b>	<b>1-3", 3-4", 1-5", 1-6" (G-Cart)</b>
<b>NET WEIGHT</b>	<b>740lbs</b>
<b>MSRP</b>	<b>\$11125.00</b>

**ULTRA SERIES - BRISTOL**

- GW4-88 Wall 88w x 24h x 16d
- GB-88 Base 88w x 42.75h x 24d
- GSCS-28 Closet 28w x 85h x 26d
- GSCH-28L Closet 28w x 85h x 26d
- G-CART Cart 40w x 36.625h x 24d
- GasketLoc Countertop - 40.5
- MotionLatch Doors
- MotionLatch Drawers
- Heavy-Duty Drawer Liner
- Adjust-A-Loc Shelves
- Heavy-Duty Shelf Liner
- Snag-Free Radius Corners
- Hanger Bar
- Adjustable Toe Kick
- Heavy-Duty Casters



**POWDER COAT COLORS:**



\* ANY STANDARD PRODUCT CAN BE CUSTOMIZED TO YOUR SPECIFIC NEEDS, PLEASE CALL 715-355-8842 AND TALK TO YOUR CTECH REPRESENTATIVE TODAY. \*

<b>SPECIFICATIONS:</b>	<b>KNOXVILLE</b>
<b>WIDTH</b>	<b>144"</b>
<b>HEIGHT</b>	<b>85"</b>
<b>DEPTH</b>	<b>26"</b>
<b>LOAD CAPACITY</b>	<i>250 lbs per drawer/ shelf</i>
<b>DRAWERS</b>	<b>1-3", 3-4", 1-5", 1-6" (G-Cart) 2-4" (Base Cabinet)</b>
<b>NET WEIGHT</b>	<b>786lbs</b>
<b>MSRP</b>	<b>\$11525.00</b>



**ULTRA SERIES - KNOXVILLE**

- GW4-88 Wall 88w x 24h x 16d
- GBC-88 Base 88w x 42.75h x 24d
- GSCS-28 Closet 28w x 85h x 26d
- GSCH-28L Closet 28w x 85h x 26d
- G-CART Cart 40w x 36.625h x 24d
- GasketLoc Countertop - 40.5h
- MotionLatch Doors
- MotionLatch Drawers
- Heavy-Duty Drawer Liner
- Adjust-A-Loc Shelves
- Heavy-Duty Shelf Liner
- Snag-Free Radius Corners
- Hanger Bar
- Adjustable Toe Kick
- Heavy-Duty Casters

<b>SPECIFICATIONS:</b>	<b>BONNEVILLE</b>
<b>WIDTH</b>	<b>192"</b>
<b>HEIGHT</b>	<b>85"</b>
<b>DEPTH</b>	<b>26"</b>
<b>LOAD CAPACITY</b>	<i>250 lbs per drawer/ shelf</i>
<b>DRAWERS</b>	<b>NA</b>
<b>NET WEIGHT</b>	<b>692lbs</b>
<b>MSRP</b>	<b>\$10575.00</b>



**ULTRA SERIES - BONNEVILLE**

- GW4-88 Wall 88w x 24h x 16d
- GB-88 Base 88w x 42.75h x 24d
- GSCS-52 Closet 52w x 85h x 26d
- GSCH-52 Closet 52w x 85h x 26d
- GasketLoc Countertop - 40.5h
- MotionLatch Doors
- Adjust-A-Loc Shelves
- Heavy-Duty Shelf Liner
- Snag-Free Radius Corners
- Hanger Bar
- Adjustable Toe Kick

**POWDER COAT COLORS:**



\* ANY STANDARD PRODUCT CAN BE CUSTOMIZED TO YOUR SPECIFIC NEEDS, PLEASE CALL 715-355-8842 AND TALK TO YOUR CTECH REPRESENTATIVE TODAY. \*





<b>SPECIFICATIONS:</b>	<b>INDY</b>
<b>WIDTH</b>	<b>192"</b>
<b>HEIGHT</b>	<b>85"</b>
<b>DEPTH</b>	<b>26"</b>
<b>LOAD CAPACITY</b>	<b>250 lbs per drawer/ shelf</b>
<b>DRAWERS</b>	<b>1-3", 3-4", 1-5", 1-6" (G-Cart)</b>
<b>NET WEIGHT</b>	<b>897lbs</b>
<b>MSRP</b>	<b>\$13450.00</b>

- ULTRA SERIES - INDY**
- GW4-88 Wall 88w x 24h x 16d
  - GB-88 Base 88w x 42.75h x 24d
  - GSCS-52 Closet 52w x 85h x 26d
  - GSCH-52 Closet 52w x 85h x 26d
  - G-CART Cart 40w x 36.625h x 24d
  - GasketLoc Countertop - 40.5h
  - MotionLatch Doors
  - MotionLatch Drawers
  - Heavy-Duty Drawer Liner
  - Adjust-A-Loc Shelves
  - Heavy-Duty Shelf Liner
  - Snag-Free Radius Corners
  - Hanger Bar
  - Adjustable Toe Kick
  - Heavy-Duty Casters

<b>SPECIFICATIONS:</b>	<b>LIMEROCK-L &amp; LIMEROCK-R</b>
<b>WIDTH</b>	<b>124.5"</b>
<b>HEIGHT</b>	<b>85"</b>
<b>DEPTH</b>	<b>76"</b>
<b>LOAD CAPACITY</b>	<b>250 lbs per drawer/ shelf</b>
<b>DRAWERS</b>	<b>1-3", 3-4", 1-5", 1-6" (G-Cart) 1-3", 3-5", 3-7" (Com- bo Closet)</b>
<b>NET WEIGHT</b>	<b>966lbs</b>
<b>MSRP</b>	<b>\$13625.00</b>

- ULTRA SERIES - LIMEROCK**
- GCW-96.5L Corner Wall 96.5w x 24h x 48d
  - GCB-96.5L Corner Base 96.5w x 42.75h x 48d
  - G-COMBO-L Closet 28w x 85h x 26d
  - GSCH-28R Closet 28w x 85h x 26d
  - G-CART Cart 40w x 36.625h x 24d
  - GasketLoc Countertop - 40.5h
  - MotionLatch Doors
  - MotionLatch Drawers
  - Heavy-Duty Drawer Liner
  - Adjust-A-Loc Shelves
  - Heavy-Duty Shelf Liner
  - Snag-Free Radius Corners
  - Hanger Bar
  - Adjustable Toe Kick
  - Heavy-Duty Casters



All corner packages are available in right corner configurations as well

**POWDER COAT COLORS:**



\* ANY STANDARD PRODUCT CAN BE CUSTOMIZED TO YOUR SPECIFIC NEEDS, PLEASE CALL 715-355-8842 AND TALK TO YOUR CTECH REPRESENTATIVE TODAY. \*



WALL - GW3-88  
88w x 24h x 16d

Opening 1: 27.333w x 19h: Left Swing  
Opening 2: 27.333w x 19h: Right Swing  
Opening 3: 27.333w x 19h: Right Swing

MotionLatch Doors  
Adjust-A-Loc Shelves  
Heavy-Duty Shelf Liner  
Snag-Free Radius Corners  
91 lbs

**\$1661.23**



WALL - GW4-88  
88w x 24h x 16d

Opening 1: 41.75w x 19h: Pair Doors  
Opening 2: 41.75w x 19h: Pair Doors

MotionLatch Doors  
Adjust-A-Loc Shelves  
Heavy-Duty Shelf Liner  
Snag-Free Radius Corners  
105 lbs

**\$1617.75**

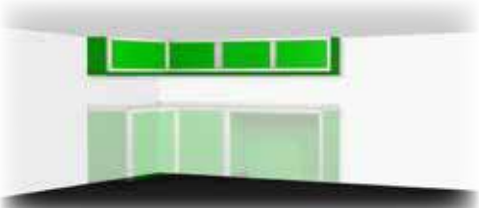

CORNER WALL - GCW-96.5L  
96.5w x 24h x 48d

Opening 1: 29w x 19h: Right Swing  
Opening 2: 24.833w x 19h: Left Swing  
Opening 3: 24.833w x 19h: Left Swing  
Opening 4: 24.833w x 19h: Right Swing

MotionLatch Doors  
Adjust-A-Loc Shelves  
Heavy-Duty Shelf Liner  
Snag-Free Radius Corners  
132 lbs

**\$2237.64**

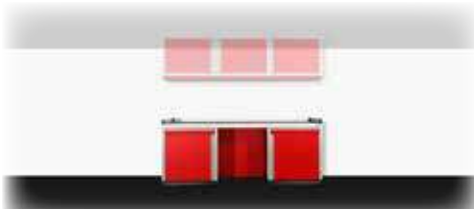

BASE - GBC37-88  
88w x 42.75h x 24d

Opening 1: 27.333w x 4.125h: Drawers: 4  
Opening 2: 27.333w x 30.875h: Left Swing  
Opening 3: 27.333w x 35h: Snap Trim  
Opening 4: 27.333w x 4.125h: Drawers: 4  
Opening 5: 27.333w x 30.875h: Right Swing

GasketLoc Countertop - 40.5h  
MotionLatch Doors  
MotionLatch Drawers  
Heavy-Duty Drawer Liner  
Adjust-A-Loc Shelves  
Heavy-Duty Shelf Liner  
Adjustable Toe Kick  
189 lbs

**\$3143.48**



BASE - GBCD-88  
88w x 42.75h x 24d

Opening 1: 27.333w x 4.125h: Drawers: 4  
Opening 2: 27.333w x 30.875h: Left Swing  
Opening 3: 27.333w x 35h: Drawers: 4, 4, 4, 6, 6, 9  
Opening 4: 27.333w x 4.125h: Drawers: 4  
Opening 5: 27.333w x 30.875h: Right Swing

GasketLoc Countertop - 40.5h  
MotionLatch Doors  
MotionLatch Drawers  
Heavy-Duty Drawer Liner  
Adjust-A-Loc Shelves  
Heavy-Duty Shelf Liner  
Adjustable Toe Kick  
303 lbs

**\$4493.18**



BASE - GB-88  
88w x 42.75h x 24d

Opening 1: 19w x 35h: Left Swing  
Opening 2: 44w x 35h: Snap Trim  
Opening 3: 19w x 35h: Right Swing

GasketLoc Countertop - 40.5h  
MotionLatch Doors  
Adjust-A-Loc Shelves  
Heavy-Duty Shelf Liner  
Adjustable Toe Kick  
162 lbs

**\$2552.38**



BASE - GBC-88  
88w x 42.75h x 24d

Opening 1: 19w x 4.125h: Drawers: 4  
Opening 2: 19w x 30.875h: Left Swing  
Opening 3: 44w x 35h: Snap Trim  
Opening 4: 19w x 4.125h: Drawers: 4  
Opening 5: 19w x 30.875h: Right Swing

GasketLoc Countertop - 40.5h  
MotionLatch Doors  
MotionLatch Drawers  
Heavy-Duty Drawer Liner  
Adjust-A-Loc Shelves  
Heavy-Duty Shelf Liner  
Adjustable Toe Kick  
208 lbs

**\$2989.29**



CORNER BASE - GCB-96.5L & GCB-96.5R  
96.5w x 42.75h x 48d  
Overall: 96w x 42.75h x 48d  
Main: 96w x 42.75h x 26d  
Leg: 48w x 42.75h x 26d

Opening 1: 21w x 35h: Right Swing  
Opening 2: 24w x 35h: Left Swing  
Opening 3: 44w x 35h: Snap Trim

GasketLoc Countertop - 40.5h  
MotionLatch Doors  
Adjust-A-Loc Shelves  
Heavy-Duty Shelf Liner  
Adjustable Toe Kick  
225 lbs

**\$3144.93**



CART - G-CART  
40w x 36.625h x 24d

Opening 1: 17.25w x 27.125h: Left Swing  
Opening 2: 17.25w x 27.125h: Drawers: 3, 4, 4, 4, 5, 6

MotionLatch Doors  
MotionLatch Drawers  
Heavy-Duty Drawer Liner  
Snag-Free Radius Corners  
Heavy-Duty Casters  
205 lbs

**\$3030.50**

**POWDER COAT COLORS:**



\* ANY STANDARD PRODUCT CAN BE CUSTOMIZED TO YOUR SPECIFIC NEEDS, PLEASE CALL 715-355-8842 AND TALK TO YOUR CTECH REPRESENTATIVE TODAY. \*





CLOSET - GSCH-28L  
28w x 85h x 26d

Opening 1: 21w x 80h: Left Swing

MotionLatch Doors  
Snag-Free Radius Corners  
Hanger Bar  
Adjustable Toe Kick  
128 lbs

**\$2193.48**



CLOSET - GSCH-28R  
28w x 85h x 26d

Opening 1: 21w x 80h: Right Swing

MotionLatch Doors  
Snag-Free Radius Corners  
Hanger Bar  
Adjustable Toe Kick  
128 lbs

**\$2193.48**



CLOSET - GSCS-28  
28w x 85h x 26d

Opening 1: 21w x 80h: Right Swing

MotionLatch Doors  
Adjust-A-Loc Shelves  
Heavy-Duty Shelf Liner  
Snag-Free Radius Corners  
Adjustable Toe Kick  
140 lbs

**\$2320.52**



CLOSET - GSCH-52  
52w x 85h x 26d

Opening 1: 21.75w x 80h: Left Swing  
Opening 2: 21.75w x 80h: Right Swing

MotionLatch Doors  
Adjust-A-Loc Shelves  
Heavy-Duty Shelf Liner  
Snag-Free Radius Corners  
Hanger Bar  
Adjustable Toe Kick  
205 lbs

**\$3421.69**



CLOSET - GSCS-52  
52w x 85h x 26d

Opening 1: 21.75w x 80h: Left Swing  
Opening 2: 21.75w x 80h: Right Swing

MotionLatch Doors  
Adjust-A-Loc Shelves  
Heavy-Duty Shelf Liner  
Snag-Free Radius Corners  
Adjustable Toe Kick  
220 lbs

**\$3552.28**



CLOSET - G-COMBO-L  
28w x 85h x 26d

Opening 1: 21w x 37.875h: Left Swing  
Opening 2: 21w x 40.625h: Drawers: 3, 5, 5, 7, 7, 7

MotionLatch Doors  
MotionLatch Drawers  
Heavy-Duty Drawer Liner  
Adjust-A-Loc Shelves  
Heavy-Duty Shelf Liner  
Adjustable Toe Kick  
Snag-Free Radius Corners  
276 lbs

**\$3755.75**



CLOSET - G-COMBO-R  
28w x 85h x 26d

Opening 1: 21w x 37.875h: Right Swing  
Opening 2: 21w x 40.625h: Drawers: 3, 5, 5, 7, 7, 7

MotionLatch Doors  
MotionLatch Drawers  
Heavy-Duty Drawer Liner  
Adjust-A-Loc Shelves  
Heavy-Duty Shelf Liner  
Adjustable Toe Kick  
Snag-Free Radius Corners  
276 lbs

**\$3755.75**



**POWDER COAT COLORS:**



\* ANY STANDARD PRODUCT CAN BE CUSTOMIZED TO YOUR SPECIFIC NEEDS, PLEASE CALL 715-355-8842 AND TALK TO YOUR CTECH REPRESENTATIVE TODAY. \*

# VAN / TRUCK



*Mobile manufacturing / welding lab*

CTech cabinets have always been designed for mobile applications and utilizing these premium cabinets in vans, trucks, and trailers of all shapes and sizes makes perfect sense. CTech gives a showroom finish with the durability to hold up to extreme conditions on and off the road.



*Petroleum service van*





*Mobile workshops engineered to give you the luxuries of your workshop on the road.*

*Van outfitters like TouRig specialize in adventure van builds. This market requires custom solutions which only CTech can provide. Each build is unique and the cabinets are built to order.*



CABINETS

**POWDER COAT COLORS:**



\* ANY STANDARD PRODUCT CAN BE CUSTOMIZED TO YOUR SPECIFIC NEEDS, PLEASE CALL 715-355-8842 AND TALK TO YOUR CTECH REPRESENTATIVE TODAY. \*

# CABINET OPTIONS

\* ANY STANDARD PRODUCT CAN BE CUSTOMIZED TO YOUR SPECIFIC NEEDS, PLEASE CALL 715-355-8842 AND TALK TO YOUR CTECH REPRESENTATIVE TODAY. \*

## FLOOR & LEG OPTIONS:



None



Adjustable Feet



Toe Kick with Adjustable Hidden Feet

## COUNTERTOP: BASE CABINET / WORKBENCH:



GasketLoc Countertop  
- Gray Laminate, STANDARD



GasketLoc Countertop  
- Stainless Overlay



Laminate  
- ships with or sourced by customer/installer



Granite  
- sourced by customer/installer



Butcher Block  
- Standard cabinet style mounting



POWER OPTIONS:



Electrical Racks  
- component racking for any opening

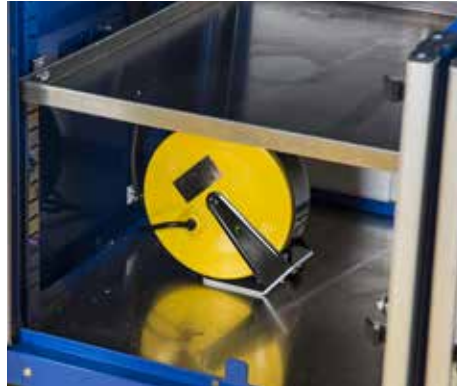

Electrical Reel



Pre-Wired Options  
- HDMI, USB, RCA, and Power

ADDITIONAL OPTIONS:



Radius End Panels



LED Lighting



Fold Away Counter Top



Louver Venting



Oval Venting



Locker Door Venting



Akro Bin Storage



Pull Out Peg Board Storage

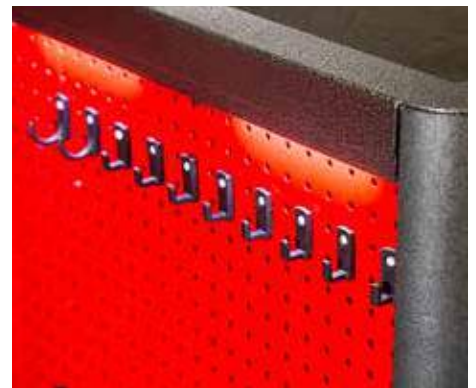

Peg Board

ADDITIONAL OPTIONS:

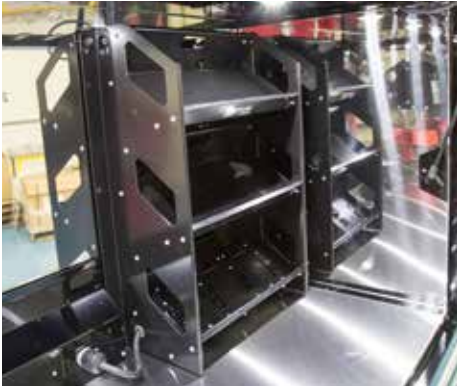

Power Docking Station



Vise - solid mount



Vise - flip away



Locks



Roll-up Door



Bench cushions



Fire Extinguisher



First Aid Cabinet



Display Door



Lift off door



Notching for obstacles



Mini Refrigerator opening



ADDITIONAL OPTIONS:



Accent Panels

- available on door and filler panels



Storage Steps



Microwave Opening

- designed to fit any microwave



Tube Storage



MotionLatch™ Pull-Out Shelves



Gas Shock door stay - STANDARD



Shelf Liner

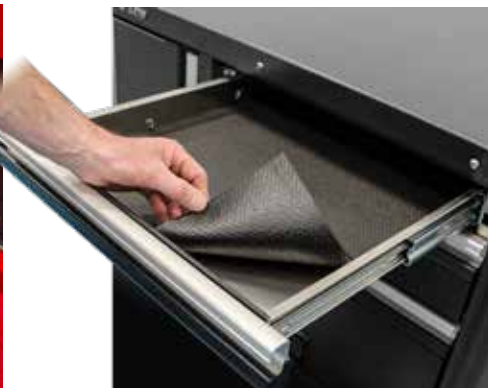

Liner - heavy duty reinforced industrial liner



Parts Tray -

Trim to fit, Leak proof, Easy to clean



DIV 2 -

1 fixed (front to back) divider, 4 adjustable (side to side) dividers



DIV 3 -

2 fixed (front to back) divider, 6 adjustable (side to side) dividers



Front to Back -

4 adjustable dividers





*Ferrari themed Motorsports Complex garage near Road America Elkhart Lake, WI.*

# GARAGE



*ULTRA Series with custom 2 tone (black,clear) extrusion color for framework and race flags.*



*Custom workshop and show garage with multiple workstations.*



*CATERPILLAR inspired roller cabinet with MotionLatch™ pullout shelves in closet and pullout peg board storage in the upper right cabinet.*

*HAAS F1 Racing shop  
- custom islands with electrical*



# SHOP







*Blackdog Speed Shop  
- each bay is outfitted with CTech islands in  
the speed shop as well as the race shop*







Trailer nose  
overhead cabinets  
with MotionLatch™  
drawers

# TRAILER



Custom stacker trailer for  
Greenheck Racing



*Dirt Bike racing trailer featuring cabinets with Black Line Accessory Benches*



*PING Golf Tour trailer*



*The Florida Gators rely on GATORADE to quench their thirst and GATORADE entrusts CTech cabinets to transport their athletes fuel!*



## *SPECIALTY VEHICLE*



*Sometimes you can never have enough counter space. CTech optimizes space for the most efficient storage solution.*



*CTech offers a variety of cabinets for almost any application or industry. From industrial to luxury, CTech provides a quality solution built for you.*



*Taking the shop to Power-sport customers is Power Pac's mentality. They prefer CTech to get the tools they need to the job at hand.*



**IN BOX DESIGN**

Mount to UTV box floor - CTECH quick and easy Z Rail attachment allows for easy installation and removal of the UTV Box if needed.

# UTV BOX

**BOX REPLACEMENT DESIGN**

Mount directly to UTV frame rails





*CTECH's Gator - This custom setup was designed for mobile service to race team equipment while still providing comfortable seating.*

**DRAWER INSERTS** in this fully custom JD Gator help contribute to this awesome off road rig.





**AUTOMOTIVE**



**BUSINESS & MARKETING**



**MUNICIPALS**





# RECREATION



# EDUCATION



# INVENTORY MANAGEMENT





# SHOW GARAGE



# RACE SHOP



# FACILITY





*RETAIL*



*RACE TRAILER*



*MOTORSPORTS*





# TOOL DRAW

**NOW OFFERING  
6 STANDARD COLORS**



**ENGINEERED TO FIT**



# OVER UNITS



ANY MANUFACTURER



**MotionLatch™ Drawers \***

“ONE HAND - ONE MOTION” opening function lets you grab anywhere on the extruded aluminum handle and effortlessly open our 250lb rated drawers.



**Lid Options:**

\* SEE PAGE 135

- Fixed, Telescoping, Flat  
5052 high strength aluminum

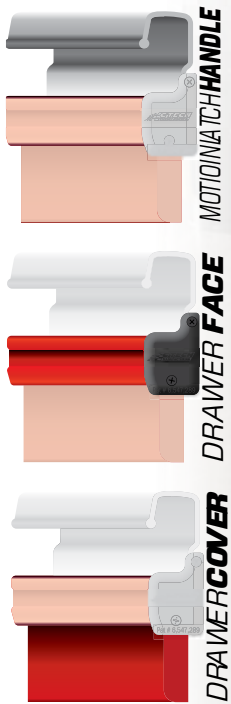

DRAWERS



**1 2 3 4 Mounting Locations**

Gives you the freedom to mount the tool drawer unit in a truck body with ease. CTech suggests a minimum of 2 mounting locations be used.  
(1) BOTTOM, (2) TOP, (3) BACK, (4) FRONT

**Aluminum Body Construction**

0.090" insert sides  
0.080" drawer body (standard)  
0.090" drawer body (extreme duty)



**5052**  
ALUMINUM  
BODY PANELS

**CTECH EXCLUSIVE**  
**MotionLatch™**  
**Drawer & Door System**  
US Patent 6,547,289



ALL ALUMINUM

POWDER  
COAT  
FINISH



Aluminum extrusion handle and drawer face

**MOTIONLATCH™ DRAWERS**

- Offers “ONE HAND - ONE MOTION” operation, even with a handful of tools
- No pinching. No squeezing. No twisting. Just pull the handle and the latches release
- MotionLatch™ opening function lets you grab anywhere on the extruded aluminum handle and effortlessly open our 250lb rated drawers
- Lightweight construction from 5052 aluminum alloy delivers superior strength with less weight



Dual-composite latches, 250 lbs drawer slides

DRAWERS



## **DRAWER INSERT**

- Perfect for carts, cabinets, or any other opening with a front lip available for mounting
- Utilize the full width of the opening with drawers
- Typically designed for openings with no door

- (3) mount locations:
  1. Front flange
  2. Rear flange
  3. Floor flange (optional add-on)



## **TOOL DRAWER INSERT - CLEAR OPENING**

- Designed to accommodate obstructions such as hinges, brackets, latches, etc. that may intrude into the opening
- Typically designed for openings with doors or other obstructions
- (4) mount locations: minimum of 2

- (4) mount locations:
  1. Front flange
  2. Rear flange
  3. Floor flange
  4. Top (FLAT, FIXED TRAY, TELESCOPING TRAY, NONE)



## **DRAWER HOUSING INSERT**

- This free-standing unit is the perfect solution for a self-containing drawer stack
- Also makes a great free standing cabinet

- (3) mount locations:
  - Top, Feet, or Back





**BOLT BIN**

- 5052 All-Aluminum Construction
- Customizable - Vertical and Horizontal configurations
- 3 adjustable separators per bin
- Stop tab at full extension
- Easily removable bins
- Multiple mounting locations
- Easy to grab handle
- Choose your riser/bottom space

*Standard units and pricing see page 130-131*

**CONVENIENT  
REMOVABLE  
STORAGE SOLUTIONS**

**DRAWERS**

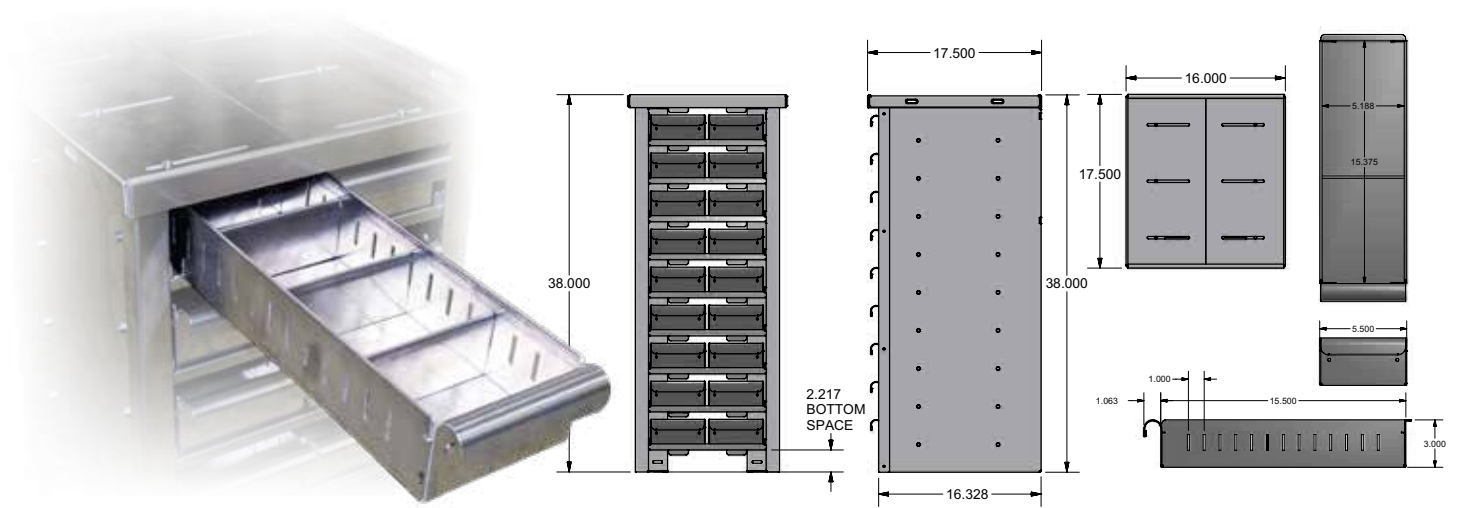



# TOOL DRAWERS

Designed to accommodate most compartment openings for any truck body manufacturer. Our aluminum tool drawer units allow for more efficient storage with the security of MotionLatch™ drawers. Available in 6 standard powder coat colors and many standard configurations guaranteed to fit. C-Tech also has the ability to customize drawers to make one all your own.

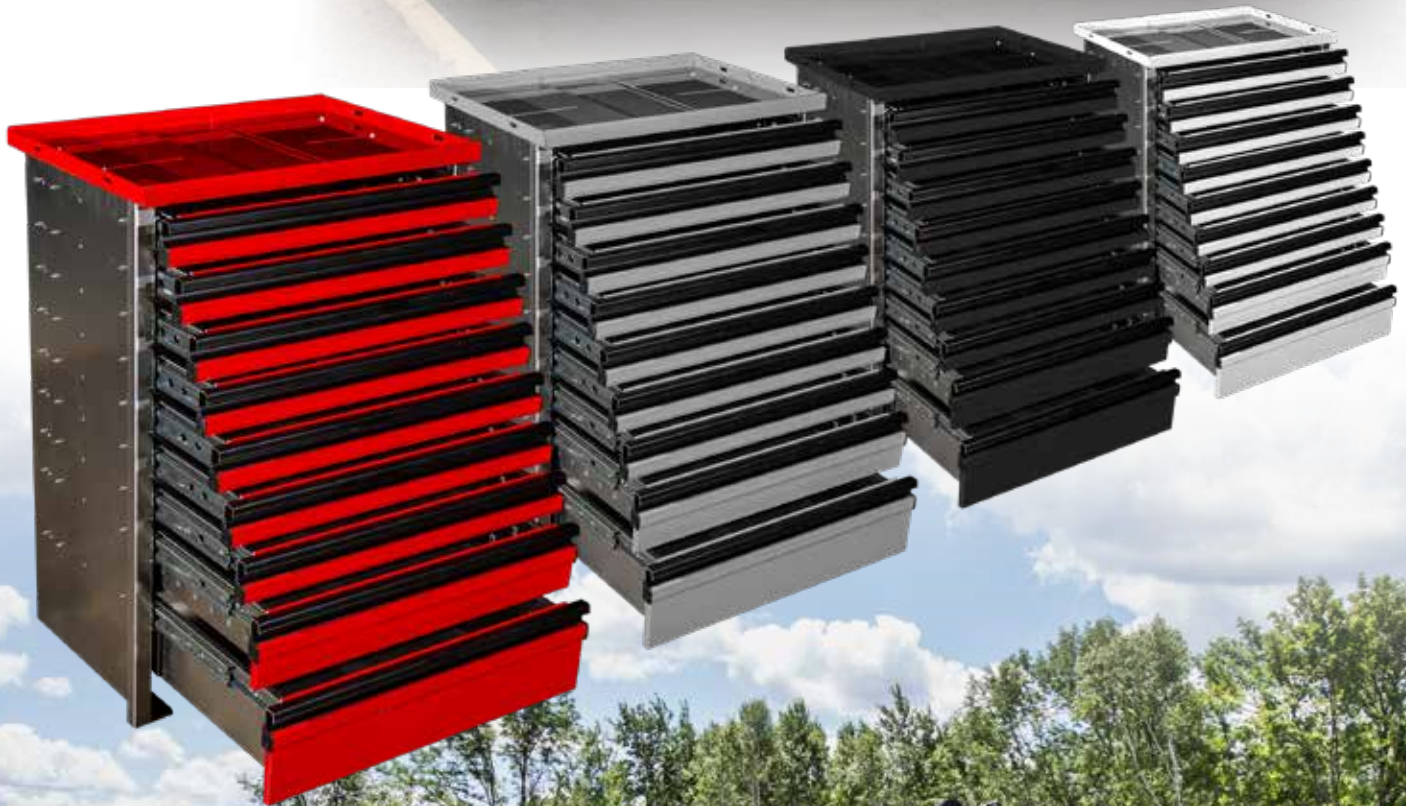

DRAWERS





**ENGINEERED TO FIT:**  
**KNAPHEIDE**  
SINCE 1848

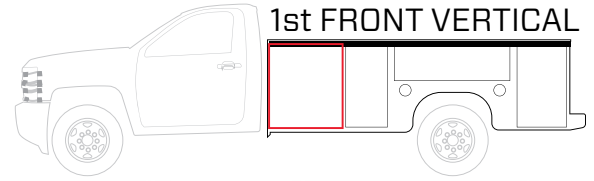

1st FRONT VERTICAL

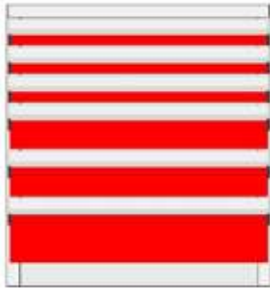

PRODUCT #:	20192514
WIDTH	28"
HEIGHT	29.82"
DEPTH	17.5"
LOAD CAPACITY	250 lbs per drawer
DRAWERS	3-3", 2-5", 1-7"
SHELF TYPE	Telescoping
NOTCH	NA
FITMENT	6108DJ, 6108FJ40, 6108D54J, 6108D54FJ40, KC108-2094J, 6132DJ, 6132DFJ40, 6132D54J, 6132D54FJ40
MSRP	\$1383.82

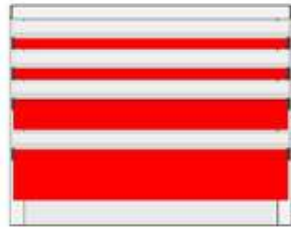

PRODUCT #:	20192522
WIDTH	28"
HEIGHT	21.82"
DEPTH	17.5"
LOAD CAPACITY	250 lbs per drawer
DRAWERS	2-3", 1-5", 1-7"
SHELF TYPE	Telescoping
NOTCH	NA
FITMENT	6108DJ, 6108FJ40, 6108D54J, 6108D54FJ40, KC108-2094J, 6132DJ, 6132DFJ40, 6132D54J, 6132D54FJ40
MSRP	\$1027.84



PRODUCT #:	700104
WIDTH	24"
HEIGHT	31.82"
DEPTH	12"
LOAD CAPACITY	250 lbs per drawer
DRAWERS	4-3", 1-5"
SHELF TYPE	Telescoping
NOTCH	13.375h x 4.125d
FITMENT	696J, 696FJ40, KC96-1478J
MSRP	\$934.51

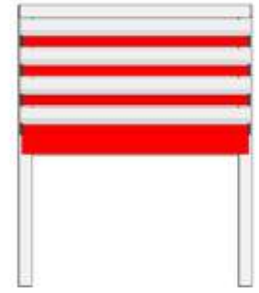

PRODUCT #:	700105
WIDTH	24"
HEIGHT	28.82"
DEPTH	12"
LOAD CAPACITY	250 lbs per drawer
DRAWERS	3-3", 1-5"
SHELF TYPE	Telescoping
NOTCH	13.375h x 4.125d
FITMENT	696J, 696FJ40, KC96-1478J
MSRP	\$812.10

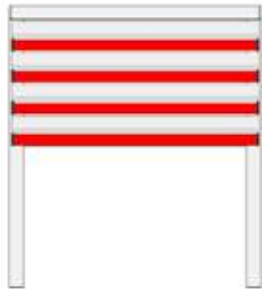

PRODUCT #:	700106
WIDTH	24"
HEIGHT	26.82"
DEPTH	12"
LOAD CAPACITY	250 lbs per drawer
DRAWERS	4-3"
SHELF TYPE	Telescoping
NOTCH	13.375h x 4.125d
FITMENT	696J, 696FJ40, KC96-1478J
MSRP	\$770.88



PRODUCT #:	700109
WIDTH	28"
HEIGHT	31.82"
DEPTH	17.5"
LOAD CAPACITY	250 lbs per drawer
DRAWERS	2-3", 1-4", 1-5", 1-6", 1-7"
SHELF TYPE	Telescoping
NOTCH	NA
FITMENT	6108DJ, 6108FJ40, 6108D54J, 6108D54FJ40, KC108-2094J, 6132DJ, 6132DFJ40, 6132D54J, 6132D54FJ40
MSRP	\$1427.18



PRODUCT #:	700111
WIDTH	28"
HEIGHT	24.82"
DEPTH	17.5"
LOAD CAPACITY	250 lbs per drawer
DRAWERS	3-3", 1-5", 1-7"
SHELF TYPE	Telescoping
NOTCH	NA
FITMENT	6108DJ, 6108FJ40, 6108D54J, 6108D54FJ40, KC108-2094J, 6132DJ, 6132DFJ40, 6132D54J, 6132D54FJ40
MSRP	\$1181.64



PRODUCT #:	700112
WIDTH	34"
HEIGHT	39.82"
DEPTH	19.5"
LOAD CAPACITY	250 lbs per drawer
DRAWERS	4-3", 2-5", 2-7"
SHELF TYPE	Telescoping
NOTCH	NA
FITMENT	KMT1-11 STREET
MSRP	\$2079.09

**POWDER COAT COLORS:**



ANY STANDARD PRODUCT CAN BE CUSTOMIZED TO YOUR SPECIFIC NEEDS, PLEASE CALL 715-355-8842 AND TALK TO YOUR CTECH REPRESENTATIVE TODAY.

DRAWERS

ENGINEERED TO FIT:

**KNAPHEIDE**

CONTINUED...

SINCE 1848

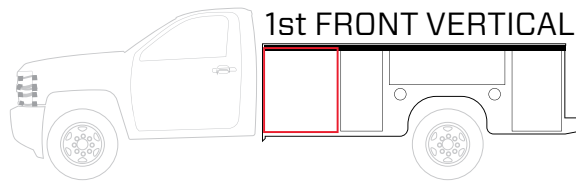

1st FRONT VERTICAL

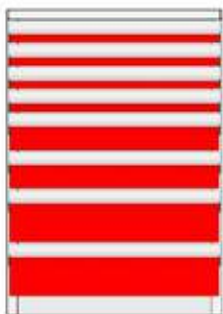

PRODUCT #:	700113
WIDTH	28"
HEIGHT	39.82"
DEPTH	19.5"
LOAD CAPACITY	250 lbs per drawer
DRAWERS	4-3", 2-5", 2-7"
SHELF TYPE	Telescoping
NOTCH	NA
FITMENT	KMT1-11 CURB
MSRP	\$1870.44

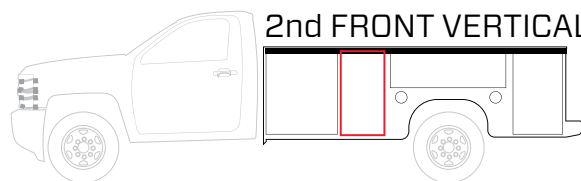

2nd FRONT VERTICAL



PRODUCT #:	700114
WIDTH	13"
HEIGHT	39.82"
DEPTH	19.5"
LOAD CAPACITY	250 lbs per drawer
DRAWERS	4-3", 2-5", 2-7"
SHELF TYPE	Telescoping
NOTCH	NA
FITMENT	KMT1-11 STREET
MSRP	\$1348.80



PRODUCT #:	700115
WIDTH	16.5"
HEIGHT	39.82"
DEPTH	19.5"
LOAD CAPACITY	250 lbs per drawer
DRAWERS	4-3", 2-5", 2-7"
SHELF TYPE	Telescoping
NOTCH	NA
FITMENT	KMT1-11 CURB
MSRP	\$1470.52



PRODUCT #:	700107
WIDTH	14"
HEIGHT	29.82"
DEPTH	17.5"
LOAD CAPACITY	250 lbs per drawer
DRAWERS	3-3", 2-5", 1-7"
SHELF TYPE	Telescoping
NOTCH	NA
FITMENT	6132DJ, 6132DFJ40, 6132D54J, 6132D54FJ40
MSRP	\$1035.06



PRODUCT #:	700108
WIDTH	14"
HEIGHT	24.82"
DEPTH	17.5"
LOAD CAPACITY	250 lbs per drawer
DRAWERS	3-3", 1-5", 1-7"
SHELF TYPE	Telescoping
NOTCH	NA
FITMENT	6132DJ, 6132DFJ40, 6132D54J, 6132D54FJ40
MSRP	\$887.86

**POWDER COAT COLORS:**



ANY STANDARD PRODUCT CAN BE CUSTOMIZED TO YOUR SPECIFIC NEEDS, PLEASE CALL 715-355-8842 AND TALK TO YOUR CTECH REPRESENTATIVE TODAY.



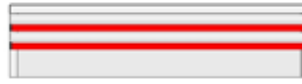
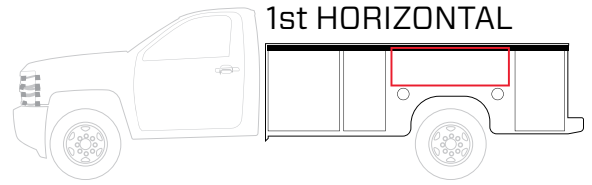

PRODUCT #:	20192506
WIDTH	42"
HEIGHT	11.82"
DEPTH	12"
LOAD CAPACITY	250 lbs per drawer
DRAWERS	2-3"
SHELF TYPE	Telescoping
NOTCH	NA
FITMENT	696J, 696FJ40, KC96-1478J
MSRP	\$618.43

PRODUCT #:	20192530
WIDTH	42"
HEIGHT	11.82"
DEPTH	17.5"
LOAD CAPACITY	250 lbs per drawer
DRAWERS	2-3"
SHELF TYPE	Telescoping
NOTCH	NA
FITMENT	6108DJ, 6108FJ40, 6108D54J, 6108D54FJ40
MSRP	\$717.36

PRODUCT #:	20192589
WIDTH	50"
HEIGHT	11.82"
DEPTH	17.5"
LOAD CAPACITY	250 lbs per drawer
DRAWERS	2-3"
SHELF TYPE	Telescoping
NOTCH	NA
FITMENT	6108DJ, 6108FJ40, 6108D54J, 6108D54FJ40
MSRP	\$739.31

PRODUCT #:	700117
WIDTH	48"
HEIGHT	15"
DEPTH	19.5"
LOAD CAPACITY	250 lbs per drawer
DRAWERS	4-3"
SHELF TYPE	Telescoping
NOTCH	NA
FITMENT	KMT1-11 STREET, KMT1-11 CURB
MSRP	\$1247.03



DRAWERS

**POWDER COAT COLORS:**



ANY STANDARD PRODUCT CAN BE CUSTOMIZED TO YOUR SPECIFIC NEEDS, PLEASE CALL 715-355-8842 AND TALK TO YOUR CTECH REPRESENTATIVE TODAY.

ENGINEERED TO FIT:

**KNAPHEIDE**

SINCE 1848

CONTINUED...

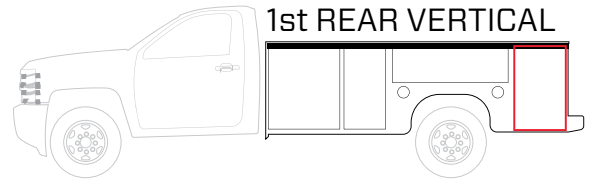

1st REAR VERTICAL



PRODUCT #:	20192548
WIDTH	20"
HEIGHT	27.82"
DEPTH	17.5"
LOAD CAPACITY	250 lbs per drawer
DRAWERS	4-3", 1-5", 1-7"
SHELF TYPE	Telescoping
NOTCH	NA
FITMENT	6108DJ, 6108FJ40, 6108D54J, 6108D54FJ40, KC108-2094J
MSRP	\$1142.31

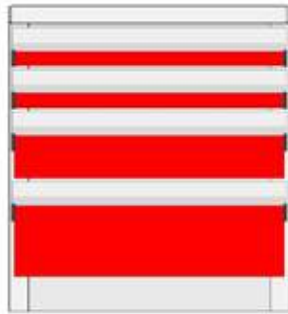

PRODUCT #:	20192555
WIDTH	20"
HEIGHT	21.82"
DEPTH	17.5"
LOAD CAPACITY	250 lbs per drawer
DRAWERS	2-3", 1-5", 1-7"
SHELF TYPE	Telescoping
NOTCH	NA
FITMENT	6108DJ, 6108FJ40, 6108D54J, 6108D54FJ40, KC108-2094
MSRP	\$885.23



PRODUCT #:	20192597
WIDTH	18"
HEIGHT	27.82"
DEPTH	17.5"
LOAD CAPACITY	250 lbs per drawer
DRAWERS	4-3", 1-5", 1-7"
SHELF TYPE	Telescoping
NOTCH	NA
FITMENT	6108DJ, 6108FJ40, 6108D54J, 6108D54FJ40
MSRP	\$1094.02

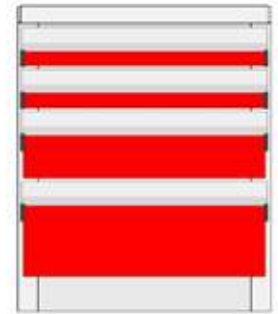

PRODUCT #:	20192605
WIDTH	18"
HEIGHT	21.82"
DEPTH	17.5"
LOAD CAPACITY	250 lbs per drawer
DRAWERS	2-3", 1-5", 1-7"
SHELF TYPE	Telescoping
NOTCH	NA
FITMENT	6132DJ, 6132DFJ40, 6132D54J, 6132D54FJ40
MSRP	\$849.57



PRODUCT #:	700116
WIDTH	19"
HEIGHT	39.82"
DEPTH	19.5"
LOAD CAPACITY	250 lbs per drawer
DRAWERS	4-3", 2-5", 2-7"
SHELF TYPE	Telescoping
NOTCH	NA
FITMENT	KMT1-11 STREET, KMT1-11 CURB
MSRP	\$1557.46



PRODUCT #:	700121
WIDTH	20"
HEIGHT	27.82"
DEPTH	17.5"
LOAD CAPACITY	250 lbs per drawer
DRAWERS	4-3", 1-5", 1-7"
SHELF TYPE	Telescoping
NOTCH	NA
FITMENT	6108DJ, 6108FJ40, 6108D54J, 6108D54FJ40, KC108-2094
MSRP	\$1142.31



PRODUCT #:	700101
WIDTH	14"
HEIGHT	28.82"
DEPTH	12"
LOAD CAPACITY	250 lbs per drawer
DRAWERS	4-3", 1-5"
SHELF TYPE	Telescoping
NOTCH	10.375h x 4.125d
FITMENT	696J, 696FJ40, KC96-1478J
MSRP	\$754.51



PRODUCT #:	700102
WIDTH	14"
HEIGHT	25.82"
DEPTH	12"
LOAD CAPACITY	250 lbs per drawer
DRAWERS	3-3", 1-5"
SHELF TYPE	Telescoping
NOTCH	10.375h x 4.125d
FITMENT	696J, 696FJ40, KC96-1478J
MSRP	\$658.89

DRAWERS

**POWDER COAT COLORS:**



ANY STANDARD PRODUCT CAN BE CUSTOMIZED TO YOUR SPECIFIC NEEDS, PLEASE CALL 715-355-8842 AND TALK TO YOUR CTECH REPRESENTATIVE TODAY.



ENGINEERED TO FIT:

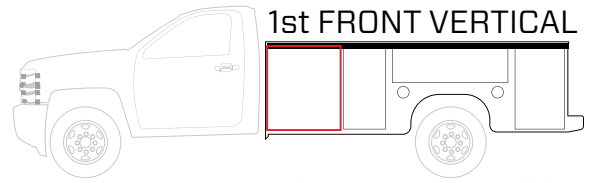

1st FRONT VERTICAL



PRODUCT #:	580101
WIDTH	28.5"
HEIGHT	30.5"
DEPTH	18.5"
LOAD CAPACITY	250 lbs per drawer
DRAWERS	3-3", 2-5", 1-7"
SHELF TYPE	Telescoping
NOTCH	NA
FITMENT	Dominator I 9ft/11ft, 1" negative offset on rear of tray Dominator II 11ft/13ft/14ft
MSRP	\$1439.87

PRODUCT #:	580102
WIDTH	28.5"
HEIGHT	38.5"
DEPTH	18.5"
LOAD CAPACITY	250 lbs per drawer
DRAWERS	4-3", 1-4", 1-5", 1-6", 1-7"
SHELF TYPE	Telescoping
NOTCH	NA
FITMENT	Dominator I 9ft/11ft, 1" negative offset on rear of tray Dominator II 11ft/13ft/14ft
MSRP	\$1805.11

PRODUCT #:	580111
WIDTH	33.25"
HEIGHT	30.5"
DEPTH	18.5"
LOAD CAPACITY	250 lbs per drawer
DRAWERS	3-3", 2-5", 1-7"
SHELF TYPE	Telescoping
NOTCH	NA
FITMENT	Dominator III 13ft, 1" negative offset on rear of tray Dominator IV 19ft
MSRP	\$1561.49

PRODUCT #:	580112
WIDTH	33.25"
HEIGHT	38.5"
DEPTH	18.5"
LOAD CAPACITY	250 lbs per drawer
DRAWERS	4-3", 1-4", 1-5", 1-6", 1-7"
SHELF TYPE	Telescoping
NOTCH	NA
FITMENT	Dominator III 13ft, 1" negative offset on rear of tray Dominator IV 19ft
MSRP	\$1961.21



PRODUCT #:	580123
WIDTH	28.5"
HEIGHT	33.5"
DEPTH	18.5"
LOAD CAPACITY	250 lbs per drawer
DRAWERS	4-3", 2-5", 1-7"
SHELF TYPE	Telescoping
NOTCH	NA
FITMENT	Dominator I 9ft/11ft, 1" negative offset on rear of tray Dominator II 11ft/13ft/14ft
MSRP	\$1600.25

PRODUCT #:	580124
WIDTH	28.5"
HEIGHT	36.5"
DEPTH	18.5"
LOAD CAPACITY	250 lbs per drawer
DRAWERS	5-3", 2-5", 1-7"
SHELF TYPE	Telescoping
NOTCH	NA
FITMENT	Dominator I 9ft/11ft, 1" negative offset on rear of tray Dominator II 11ft/13ft/14ft
MSRP	\$1760.62



DRAWERS

POWDER COAT COLORS:



ANY STANDARD PRODUCT CAN BE CUSTOMIZED TO YOUR SPECIFIC NEEDS, PLEASE CALL 715-355-8842 AND TALK TO YOUR CTECH REPRESENTATIVE TODAY.

ENGINEERED TO FIT:



CONTINUED...

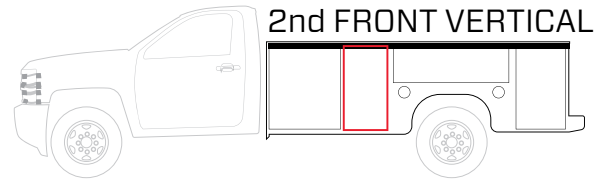

PRODUCT #:	580103
WIDTH	15.25"
HEIGHT	30.5"
DEPTH	18.5"
LOAD CAPACITY	250 lbs per drawer
DRAWERS	3-3", 2-5", 1-7"
SHELF TYPE	Telescoping
NOTCH	NA
FITMENT	Dominator I 11ft 1" negative offset on rear of tray
MSRP	\$1100.62

PRODUCT #:	580104
WIDTH	15.25"
HEIGHT	38.5"
DEPTH	18.5"
LOAD CAPACITY	250 lbs per drawer
DRAWERS	4-3", 1-4", 1-5", 1-6", 1-7"
SHELF TYPE	Telescoping
NOTCH	NA
FITMENT	Dominator I 11ft 1" negative offset on rear of tray
MSRP	\$1369.68

PRODUCT #:	580107
WIDTH	16.75"
HEIGHT	30.5"
DEPTH	18.5"
LOAD CAPACITY	250 lbs per drawer
DRAWERS	3-3", 2-5", 1-7"
SHELF TYPE	Telescoping
NOTCH	NA
FITMENT	Dominator I 9ft/11ft, Dominator II 11ft/13ft/14ft 1" negative offset on rear of tray
MSRP	\$1139.02

PRODUCT #:	580108
WIDTH	16.75"
HEIGHT	38.5"
DEPTH	18.5"
LOAD CAPACITY	250 lbs per drawer
DRAWERS	4-3", 1-4", 1-5", 1-6", 1-7"
SHELF TYPE	Telescoping
NOTCH	NA
FITMENT	Dominator II 13ft 1" negative offset on rear of tray
MSRP	\$1418.97

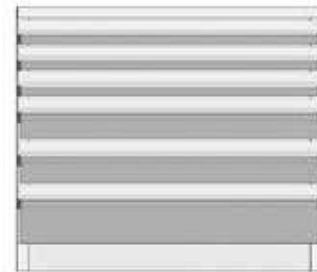

PRODUCT #:	580113
WIDTH	24.5"
HEIGHT	30.5"
DEPTH	18.5"
LOAD CAPACITY	250 lbs per drawer
DRAWERS	3-3", 2-5", 1-7"
SHELF TYPE	Telescoping
NOTCH	NA
FITMENT	Dominator II 13ft 1" negative offset on rear of tray
MSRP	\$1337.46

PRODUCT #:	580114
WIDTH	24.5"
HEIGHT	38.5"
DEPTH	18.5"
LOAD CAPACITY	250 lbs per drawer
DRAWERS	4-3", 1-4", 1-5", 1-6", 1-7"
SHELF TYPE	Telescoping
NOTCH	NA
FITMENT	Dominator III 13ft 1" negative offset on rear of tray
MSRP	\$1673.66

PRODUCT #:	580121
WIDTH	35.25"
HEIGHT	30.5"
DEPTH	18.5"
LOAD CAPACITY	250 lbs per drawer
DRAWERS	3-3", 2-5", 1-7"
SHELF TYPE	Telescoping
NOTCH	NA
FITMENT	Dominator IV 19ft 1" negative offset on rear of tray
MSRP	\$1612.70

POWDER COAT COLORS:



ANY STANDARD PRODUCT CAN BE CUSTOMIZED TO YOUR SPECIFIC NEEDS, PLEASE CALL 715-355-8842 AND TALK TO YOUR CTECH REPRESENTATIVE TODAY.



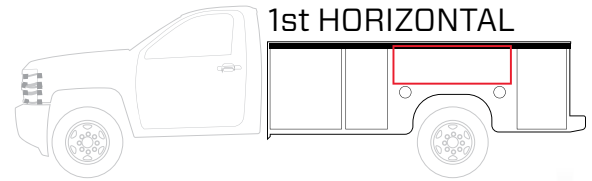

PRODUCT #:	580105
WIDTH	41"
HEIGHT	11.82"
DEPTH	18.5"
LOAD CAPACITY	250 lbs per drawer
DRAWERS	2-3", 1-4"
SHELF TYPE	Telescoping
NOTCH	NA
FITMENT	Dominator I 9ft 1" negative offset on rear of tray
MSRP	\$933.41

PRODUCT #:	580106
WIDTH	41"
HEIGHT	16.82"
DEPTH	18.5"
LOAD CAPACITY	250 lbs per drawer
DRAWERS	5-3"
SHELF TYPE	Telescoping
NOTCH	NA
FITMENT	Dominator I 9ft 1" negative offset on rear of tray
MSRP	\$1303.22

PRODUCT #:	580109
WIDTH	43"
HEIGHT	11.82"
DEPTH	18.5"
LOAD CAPACITY	250 lbs per drawer
DRAWERS	2-3", 1-4"
SHELF TYPE	Telescoping
NOTCH	NA
FITMENT	Dominator I 11ft, Dominator II 11ft/13ft 1" negative offset on rear of tray
MSRP	\$958.69

PRODUCT #:	580110
WIDTH	43"
HEIGHT	16.82"
DEPTH	18.5"
LOAD CAPACITY	250 lbs per drawer
DRAWERS	3-3", 2-5", 1-7"
SHELF TYPE	Telescoping
NOTCH	NA
FITMENT	Dominator III 13ft, Dominator IV 19ft 1" negative offset on rear of tray
MSRP	\$1340.70



PRODUCT #:	580115
WIDTH	45"
HEIGHT	11.82"
DEPTH	18.5"
LOAD CAPACITY	250 lbs per drawer
DRAWERS	2-3", 1-4"
SHELF TYPE	Telescoping
NOTCH	NA
FITMENT	Dominator III 13ft 1" negative offset on rear of tray
MSRP	\$983.96

PRODUCT #:	580116
WIDTH	45"
HEIGHT	16.82"
DEPTH	18.5"
LOAD CAPACITY	250 lbs per drawer
DRAWERS	5-3"
SHELF TYPE	Telescoping
NOTCH	NA
FITMENT	Dominator I 9ft 1" negative offset on rear of tray
MSRP	\$1378.18

PRODUCT #:	580119
WIDTH	49"
HEIGHT	11.82"
DEPTH	18.5"
LOAD CAPACITY	250 lbs per drawer
DRAWERS	2-3", 1-4"
SHELF TYPE	Telescoping
NOTCH	NA
FITMENT	Dominator IV 19ft & SECOND HORIZONTAL 1" negative offset on rear of tray
MSRP	\$1034.51

PRODUCT #:	580120
WIDTH	49"
HEIGHT	16.82"
DEPTH	18.5"
LOAD CAPACITY	250 lbs per drawer
DRAWERS	5-3"
SHELF TYPE	Telescoping
NOTCH	NA
FITMENT	Dominator IV 19ft & SECOND HORIZONTAL 1" negative offset on rear of tray
MSRP	\$1453.15

**POWDER COAT COLORS:**



ANY STANDARD PRODUCT CAN BE CUSTOMIZED TO YOUR SPECIFIC NEEDS, PLEASE CALL 715-355-8842 AND TALK TO YOUR CTECH REPRESENTATIVE TODAY.

**ENGINEERED TO FIT:**



CONTINUED...

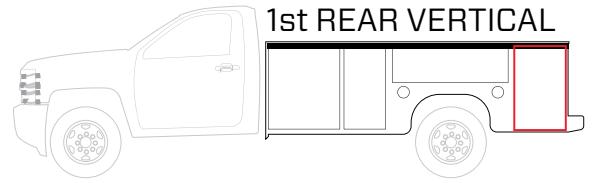

PRODUCT #:	580117
WIDTH	23"
HEIGHT	30.5"
DEPTH	18.5"
LOAD CAPACITY	250 lbs per drawer
DRAWERS	3-3", 2-5", 1-7"
SHELF TYPE	Telescoping
NOTCH	NA
FITMENT	Dominator III 13ft, Dominator IV 19ft
FITMENT	1" negative offset on rear of tray
MSRP	\$1299.05

PRODUCT #:	580118
WIDTH	23"
HEIGHT	38.5"
DEPTH	18.5"
LOAD CAPACITY	250 lbs per drawer
DRAWERS	4-3", 1-4", 1-5", 1-6", 1-7"
SHELF TYPE	Telescoping
NOTCH	NA
FITMENT	Dominator III 13ft, Dominator IV 19ft
FITMENT	1" negative offset on rear of tray
MSRP	\$1624.37

**AUTO ENGINEERED TO FIT:  
CRANE**

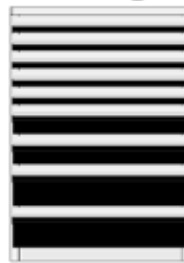
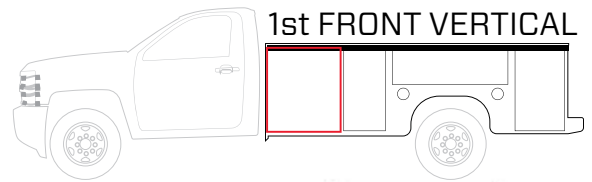

PRODUCT #:	552101
WIDTH	28"
HEIGHT	35.82"
DEPTH	18"
LOAD CAPACITY	250 lbs per drawer
DRAWERS	5-3", 2-5", 1-7"
SHELF TYPE	Telescoping
NOTCH	NA
FITMENT	Titan 38, Titan 50, Titan 60
MSRP	\$1723.40

PRODUCT #:	552105
WIDTH	30"
HEIGHT	35.82"
DEPTH	18"
LOAD CAPACITY	250 lbs per drawer
DRAWERS	5-3", 2-5", 1-7"
SHELF TYPE	Telescoping
NOTCH	NA
FITMENT	Titan 70
MSRP	\$1786.67

PRODUCT #:	552106
WIDTH	30"
HEIGHT	42.82"
DEPTH	18"
LOAD CAPACITY	250 lbs per drawer
DRAWERS	5-3", 2-5", 1-7"
SHELF TYPE	Telescoping
NOTCH	NA
FITMENT	Titan 70
MSRP	\$2047.26

PRODUCT #:	552116
WIDTH	28"
HEIGHT	42.82"
DEPTH	18"
LOAD CAPACITY	250 lbs per drawer
DRAWERS	5-3", 2-5", 2-7"
SHELF TYPE	Telescoping
NOTCH	NA
FITMENT	Titan 38, Titan 50, Titan 60
MSRP	\$1973.80

**POWDER COAT COLORS:**



ANY STANDARD PRODUCT CAN BE CUSTOMIZED TO YOUR SPECIFIC NEEDS, PLEASE CALL 715-355-8842 AND TALK TO YOUR CTECH REPRESENTATIVE TODAY.



ENGINEERED TO FIT:

**AUTO  
CRANE**®

CONTINUED...

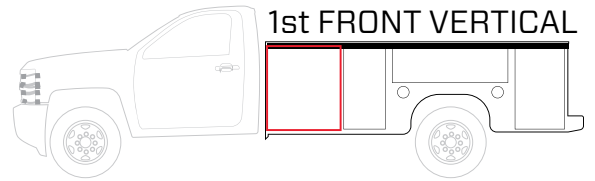

1st FRONT VERTICAL



PRODUCT #:	552121
WIDTH	28"
HEIGHT	49.82"
DEPTH	18"
LOAD CAPACITY	250 lbs per drawer
DRAWERS	5-3", 2-5", 3-7"
SHELF TYPE	Telescoping
NOTCH	NA
FITMENT	Titan 50, Titan 60
MSRP	\$2224.21

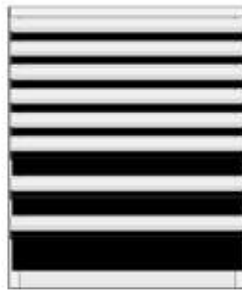

PRODUCT #:	552127
WIDTH	30"
HEIGHT	35.82"
DEPTH	16"
LOAD CAPACITY	250 lbs per drawer
DRAWERS	5-3", 2-5", 1-7"
SHELF TYPE	Telescoping
NOTCH	NA
FITMENT	Titan 16
MSRP	\$1700.36

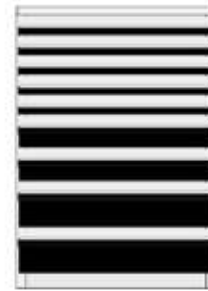

PRODUCT #:	552128
WIDTH	30"
HEIGHT	42.82"
DEPTH	18"
LOAD CAPACITY	250 lbs per drawer
DRAWERS	5-3", 2-5", 2-7"
SHELF TYPE	Telescoping
NOTCH	NA
FITMENT	Titan 16
MSRP	\$1948.81

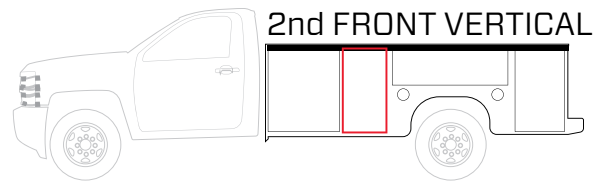

2nd FRONT VERTICAL



PRODUCT #:	552101
WIDTH	28"
HEIGHT	35.82"
DEPTH	18"
LOAD CAPACITY	250 lbs per drawer
DRAWERS	5-3", 2-5", 1-7"
SHELF TYPE	Telescoping
NOTCH	NA
FITMENT	Titan 38, Titan 50, Titan 60
MSRP	\$1723.40



PRODUCT #:	552103
WIDTH	14.5"
HEIGHT	42.82"
DEPTH	18"
LOAD CAPACITY	250 lbs per drawer
DRAWERS	5-3", 2-5", 2-7"
SHELF TYPE	Telescoping
NOTCH	NA
FITMENT	Titan 50, Titan 60, Titan 70
MSRP	\$1477.96

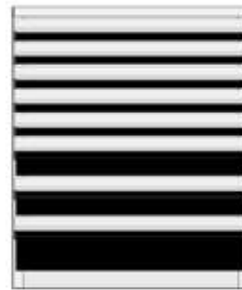

PRODUCT #:	552105
WIDTH	30"
HEIGHT	35.82"
DEPTH	18"
LOAD CAPACITY	250 lbs per drawer
DRAWERS	5-3", 2-5", 1-7"
SHELF TYPE	Telescoping
NOTCH	NA
FITMENT	Titan 70
MSRP	\$1786.67

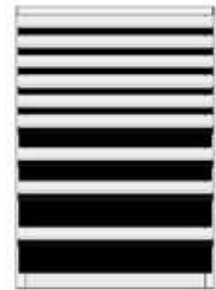

PRODUCT #:	552106
WIDTH	30"
HEIGHT	42.82"
DEPTH	18"
LOAD CAPACITY	250 lbs per drawer
DRAWERS	5-3", 2-5", 1-7"
SHELF TYPE	Telescoping
NOTCH	NA
FITMENT	Titan 70
MSRP	\$2047.26

**POWDER COAT COLORS:**



ANY STANDARD PRODUCT CAN BE CUSTOMIZED TO YOUR SPECIFIC NEEDS, PLEASE CALL 715-355-8842 AND TALK TO YOUR CTECH REPRESENTATIVE TODAY.

DRAWERS

ENGINEERED TO FIT:

**AUTO  
CRANE**

CONTINUED...

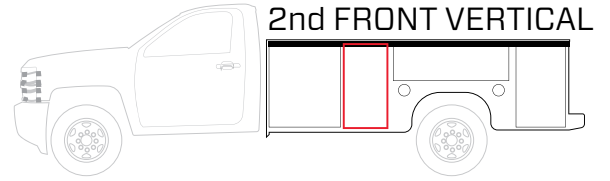

2nd FRONT VERTICAL



PRODUCT #:	552116
WIDTH	28"
HEIGHT	42.82"
DEPTH	18"
LOAD CAPACITY	250 lbs per drawer
DRAWERS	5-3", 2-5", 2-7"
SHELF TYPE	Telescoping
NOTCH	NA
FITMENT	Titan 38, Titan 50, Titan 60
MSRP	\$1973.80



PRODUCT #:	552119
WIDTH	16"
HEIGHT	35.82"
DEPTH	18"
LOAD CAPACITY	250 lbs per drawer
DRAWERS	5-3", 2-5", 3-7"
SHELF TYPE	Telescoping
NOTCH	NA
FITMENT	Titan 38
MSRP	\$1343.76



PRODUCT #:	552121
WIDTH	28"
HEIGHT	49.82"
DEPTH	18"
LOAD CAPACITY	250 lbs per drawer
DRAWERS	5-3", 2-5", 3-7"
SHELF TYPE	Telescoping
NOTCH	NA
FITMENT	Titan 50, Titan 60
MSRP	\$2224.21



PRODUCT #:	552122
WIDTH	14.5"
HEIGHT	49.82"
DEPTH	18"
LOAD CAPACITY	250 lbs per drawer
DRAWERS	5-3", 2-5", 3-7"
SHELF TYPE	Telescoping
NOTCH	NA
FITMENT	Titan 38
MSRP	\$1659.62



PRODUCT #:	552123
WIDTH	14.5"
HEIGHT	35.82"
DEPTH	18"
LOAD CAPACITY	250 lbs per drawer
DRAWERS	5-3", 2-5", 1-7"
SHELF TYPE	Telescoping
NOTCH	NA
FITMENT	Titan 50, Titan 60
MSRP	\$1296.30



PRODUCT #:	552131
WIDTH	16"
HEIGHT	35.82"
DEPTH	16"
LOAD CAPACITY	250 lbs per drawer
DRAWERS	5-3", 2-5", 1-7"
SHELF TYPE	Telescoping
NOTCH	NA
FITMENT	Titan 16
MSRP	\$1343.76



DRAWERS

**POWDER COAT COLORS:**



ANY STANDARD PRODUCT CAN BE CUSTOMIZED TO YOUR SPECIFIC NEEDS, PLEASE CALL 715-355-8842 AND TALK TO YOUR CTECH REPRESENTATIVE TODAY.



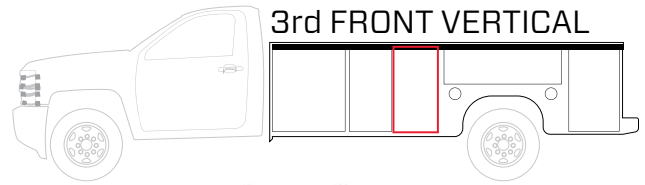

3rd FRONT VERTICAL



PRODUCT #:	552122
WIDTH	14.5"
HEIGHT	49.82"
DEPTH	18"
LOAD CAPACITY	250 lbs per drawer
DRAWERS	5-3", 2-5", 3-7"
SHELF TYPE	Telescoping
NOTCH	NA
FITMENT	Titan 38
MSRP	\$1659.62

PRODUCT #:	552123
WIDTH	14.5"
HEIGHT	35.82"
DEPTH	18"
LOAD CAPACITY	250 lbs per drawer
DRAWERS	5-3", 2-5", 1-7"
SHELF TYPE	Telescoping
NOTCH	NA
FITMENT	Titan 50, Titan 60
MSRP	\$1296.30

PRODUCT #:	552103
WIDTH	14.5"
HEIGHT	42.82"
DEPTH	18"
LOAD CAPACITY	250 lbs per drawer
DRAWERS	5-3", 2-5", 2-7"
SHELF TYPE	Telescoping
NOTCH	NA
FITMENT	Titan 50, Titan 60, Titan 70
MSRP	\$1477.96

ENGINEERED TO FIT:



CONTINUED...

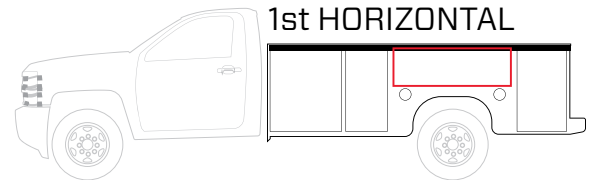

1st HORIZONTAL



PRODUCT #:	552104
WIDTH	41"
HEIGHT	12.82"
DEPTH	18"
LOAD CAPACITY	250 lbs per drawer
DRAWERS	3-3"
SHELF TYPE	Telescoping
NOTCH	NA
FITMENT	Titan 50, Titan 60
MSRP	\$905.29

PRODUCT #:	552114
WIDTH	37"
HEIGHT	12.82"
DEPTH	18"
LOAD CAPACITY	250 lbs per drawer
DRAWERS	3-3"
SHELF TYPE	Telescoping
NOTCH	NA
FITMENT	Titan 38
MSRP	\$856.48

PRODUCT #:	552117
WIDTH	41"
HEIGHT	15.82"
DEPTH	18"
LOAD CAPACITY	250 lbs per drawer
DRAWERS	4-3"
SHELF TYPE	Telescoping
NOTCH	NA
FITMENT	Titan 50, Titan 60
MSRP	\$1104.11

PRODUCT #:	552120
WIDTH	41"
HEIGHT	18.32"
DEPTH	18"
LOAD CAPACITY	250 lbs per drawer
DRAWERS	5-3"
SHELF TYPE	Telescoping
NOTCH	NA
FITMENT	Titan 50, Titan 60, Titan 70
MSRP	\$1302.94

POWDER COAT COLORS:



ANY STANDARD PRODUCT CAN BE CUSTOMIZED TO YOUR SPECIFIC NEEDS, PLEASE CALL 715-355-8842 AND TALK TO YOUR CTECH REPRESENTATIVE TODAY.

DRAWERS

ENGINEERED TO FIT:

**AUTO  
CRANE**

CONTINUED...

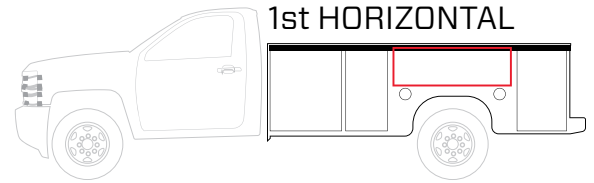

PRODUCT #:	552124
WIDTH	41"
HEIGHT	21.82"
DEPTH	18"
LOAD CAPACITY	250 lbs per drawer
DRAWERS	6-3"
SHELF TYPE	Telescoping
NOTCH	NA
FITMENT	Titan 50, Titan 60, Titan 70
MSRP	\$1501.76



PRODUCT #:	552126
WIDTH	37"
HEIGHT	15.82"
DEPTH	18"
LOAD CAPACITY	250 lbs per drawer
DRAWERS	4-3"
SHELF TYPE	Telescoping
NOTCH	NA
FITMENT	Titan 38
MSRP	\$1042.82



PRODUCT #:	552129
WIDTH	37"
HEIGHT	12.82"
DEPTH	16"
LOAD CAPACITY	250 lbs per drawer
DRAWERS	3-3"
SHELF TYPE	Telescoping
NOTCH	NA
FITMENT	Titan 16
MSRP	\$813.54



PRODUCT #:	552132
WIDTH	37"
HEIGHT	15.82"
DEPTH	16"
LOAD CAPACITY	250 lbs per drawer
DRAWERS	4-3"
SHELF TYPE	Telescoping
NOTCH	NA
FITMENT	Titan 16
MSRP	\$989.97

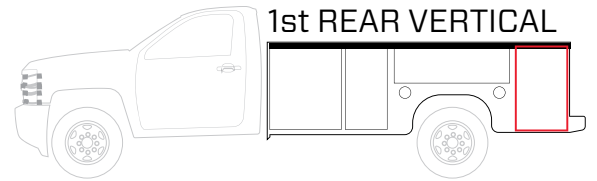

PRODUCT #:	552102
WIDTH	21"
HEIGHT	42.82"
DEPTH	18"
LOAD CAPACITY	250 lbs per drawer
DRAWERS	5-3", 2-5", 2-7"
SHELF TYPE	Telescoping
NOTCH	NA
FITMENT	Titan 50, Titan 60, Titan 70
MSRP	\$1716.70



PRODUCT #:	552107
WIDTH	21"
HEIGHT	35.82"
DEPTH	18"
LOAD CAPACITY	250 lbs per drawer
DRAWERS	5-3", 2-5", 1-7"
SHELF TYPE	Telescoping
NOTCH	NA
FITMENT	Titan 50, Titan 60, Titan 70
MSRP	\$1501.94

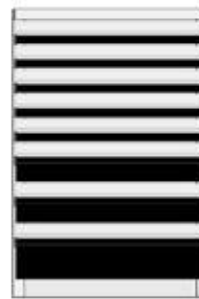

PRODUCT #:	552115
WIDTH	24"
HEIGHT	35.82"
DEPTH	18"
LOAD CAPACITY	250 lbs per drawer
DRAWERS	5-3", 2-5", 1-7"
SHELF TYPE	Telescoping
NOTCH	NA
FITMENT	Titan 38
MSRP	\$1596.85



PRODUCT #:	552125
WIDTH	21"
HEIGHT	49.82"
DEPTH	18"
LOAD CAPACITY	250 lbs per drawer
DRAWERS	5-3", 2-5", 3-7"
SHELF TYPE	Telescoping
NOTCH	NA
FITMENT	Titan 50, Titan 60, Titan 70
MSRP	\$1931.46

**POWDER COAT COLORS:**



ANY STANDARD PRODUCT CAN BE CUSTOMIZED TO YOUR SPECIFIC NEEDS, PLEASE CALL 715-355-8842 AND TALK TO YOUR CTECH REPRESENTATIVE TODAY.



ENGINEERED TO FIT:

**AUTO CRANE**

CONTINUED...

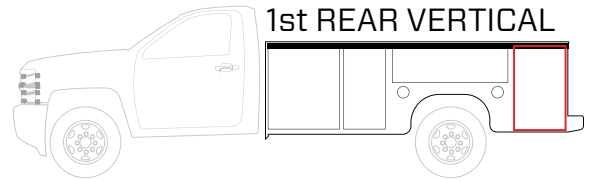

PRODUCT #:	552130
WIDTH	24"
HEIGHT	35.82"
DEPTH	16"
LOAD CAPACITY	250 lbs per drawer
DRAWERS	5-3", 2-5", 1-7"
SHELF TYPE	Telescoping
NOTCH	NA
FITMENT	Titan 16
MSRP	\$1520.39



ENGINEERED TO FIT:

**BRAND FX**  
EVERLAST TRUCK BODIES

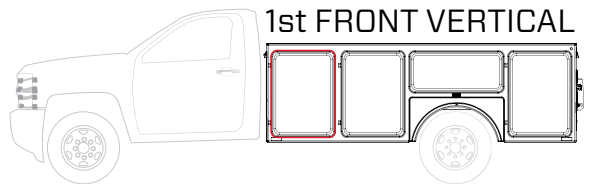

PRODUCT #:	570104
WIDTH	23.375"
HEIGHT	31.07"
DEPTH	16"
LOAD CAPACITY	250 lbs per drawer
DRAWERS	3-3", 2-5", 1-7"
SHELF TYPE	Telescoping
NOTCH	0.5h x 0.5d
FITMENT	56 DLS
MSRP	\$1237.91



PRODUCT #:	570107
WIDTH	27.75"
HEIGHT	31.07"
DEPTH	16"
LOAD CAPACITY	250 lbs per drawer
DRAWERS	3-3", 2-5", 1-7"
SHELF TYPE	Telescoping
NOTCH	0.5h x 0.5d
FITMENT	60 DLS
MSRP	\$1343.03



PRODUCT #:	570108
WIDTH	21.75"
HEIGHT	31.07"
DEPTH	16"
LOAD CAPACITY	250 lbs per drawer
DRAWERS	3-3", 2-5", 2-7"
SHELF TYPE	Telescoping
NOTCH	0.5h x 0.5d
FITMENT	84 DSL
MSRP	\$1198.87

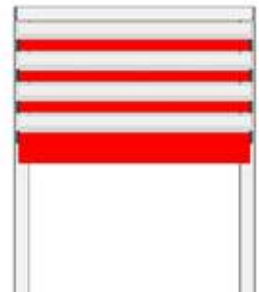

PRODUCT #:	570114
WIDTH	23.375"
HEIGHT	29.82"
DEPTH	12"
LOAD CAPACITY	250 lbs per drawer
DRAWERS	3-3", 1-5"
SHELF TYPE	Telescoping
NOTCH	14.5h x 5.5d
FITMENT	56 LS
MSRP	\$807.77

**POWDER COAT COLORS:**



ANY STANDARD PRODUCT CAN BE CUSTOMIZED TO YOUR SPECIFIC NEEDS, PLEASE CALL 715-355-8842 AND TALK TO YOUR CTECH REPRESENTATIVE TODAY.

DRAWERS

ENGINEERED TO FIT:

**BRAND FX** CONTINUED...  
EVERLAST TRUCK BODIES

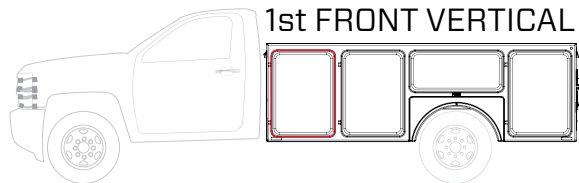

1st FRONT VERTICAL



PRODUCT #:	570115
WIDTH	23.375"
HEIGHT	27.82"
DEPTH	12"
LOAD CAPACITY	250 lbs per drawer
DRAWERS	4-3"
SHELF TYPE	Telescoping
NOTCH	14.5h x 5.5d
FITMENT	56 LS
MSRP	<b>\$767.03</b>

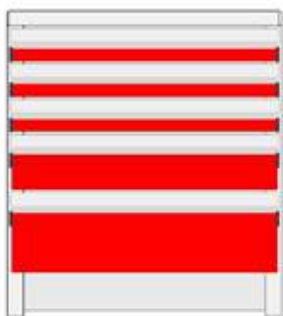

PRODUCT #:	570118
WIDTH	23.375"
HEIGHT	26.07"
DEPTH	16"
LOAD CAPACITY	250 lbs per drawer
DRAWERS	3-3", 1-5", 1-7"
SHELF TYPE	Telescoping
NOTCH	0.5h x 0.5d
FITMENT	56 DLS
MSRP	<b>\$1059.03</b>



PRODUCT #:	570119
WIDTH	27.75"
HEIGHT	26.07"
DEPTH	16"
LOAD CAPACITY	250 lbs per drawer
DRAWERS	3-3", 1-5", 1-7"
SHELF TYPE	Telescoping
NOTCH	0.5h x 0.5d
FITMENT	60 DLS
MSRP	<b>\$1147.54</b>



PRODUCT #:	570120
WIDTH	21.75"
HEIGHT	26.07"
DEPTH	16"
LOAD CAPACITY	250 lbs per drawer
DRAWERS	3-3", 1-5", 1-7"
SHELF TYPE	Telescoping
NOTCH	0.5h x 0.5d
FITMENT	84 DLS
MSRP	<b>\$1026.15</b>

DRAWERS



PRODUCT #:	570108
WIDTH	21.75"
HEIGHT	31.07"
DEPTH	16"
LOAD CAPACITY	250 lbs per drawer
DRAWERS	3-3", 2-5", 1-7"
SHELF TYPE	Telescoping
NOTCH	0.5h x 0.5d
FITMENT	84 DSL
MSRP	<b>\$1198.87</b>



PRODUCT #:	570120
WIDTH	21.75"
HEIGHT	26.07"
DEPTH	16"
LOAD CAPACITY	250 lbs per drawer
DRAWERS	3-3", 1-5", 1-7"
SHELF TYPE	Telescoping
NOTCH	0.5h x 0.5d
FITMENT	84 DLS
MSRP	<b>\$1026.15</b>

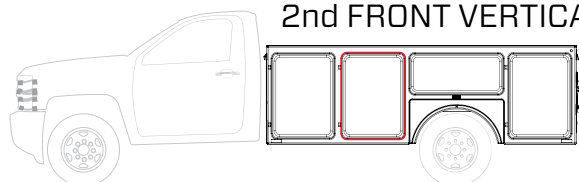

2nd FRONT VERTICAL



**POWDER COAT COLORS:**



ANY STANDARD PRODUCT CAN BE CUSTOMIZED TO YOUR SPECIFIC NEEDS, PLEASE CALL 715-355-8842 AND TALK TO YOUR CTECH REPRESENTATIVE TODAY.



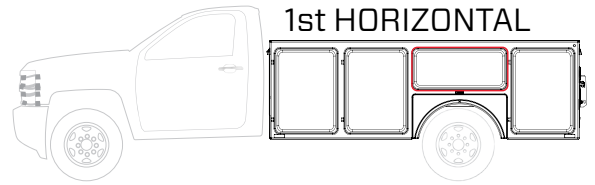

1st HORIZONTAL



PRODUCT #:	570102
WIDTH	36"
HEIGHT	11.32"
DEPTH	12"
LOAD CAPACITY	250 lbs per drawer
DRAWERS	2-3"
SHELF TYPE	Telescoping
NOTCH	0.5h x 0.5d
FITMENT	56 LS
MSRP	\$571.25

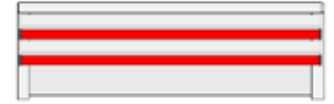

PRODUCT #:	570105
WIDTH	36"
HEIGHT	11.32"
DEPTH	16"
LOAD CAPACITY	250 lbs per drawer
DRAWERS	2-3"
SHELF TYPE	Telescoping
NOTCH	0.5h x 0.5d
FITMENT	56 DLS, 60 DLS, 84DLS
MSRP	\$637.95

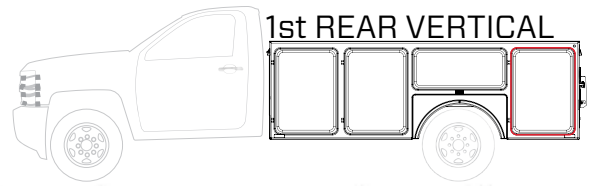

1st REAR VERTICAL

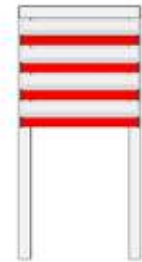

PRODUCT #:	570106
WIDTH	13.5"
HEIGHT	31.07"
DEPTH	16"
LOAD CAPACITY	250 lbs per drawer
DRAWERS	3-3", 2-5", 1-7"
SHELF TYPE	Telescoping
NOTCH	0.5h x 0.5d
FITMENT	56 DLS
MSRP	\$1000.65

PRODUCT #:	570108
WIDTH	21.75"
HEIGHT	31.07"
DEPTH	16"
LOAD CAPACITY	250 lbs per drawer
DRAWERS	3-3", 2-5", 2-7"
SHELF TYPE	Telescoping
NOTCH	0.5h x 0.5d
FITMENT	60DLS, 84 DSL
MSRP	\$1198.87

PRODUCT #:	570116
WIDTH	13.5"
HEIGHT	29.82"
DEPTH	12"
LOAD CAPACITY	250 lbs per drawer
DRAWERS	3-3", 1-5"
SHELF TYPE	Telescoping
NOTCH	14.5h x 5.5d
FITMENT	56 LS
MSRP	\$667.30

PRODUCT #:	570117
WIDTH	13.5"
HEIGHT	27.82"
DEPTH	12"
LOAD CAPACITY	250 lbs per drawer
DRAWERS	4-3"
SHELF TYPE	Telescoping
NOTCH	14.5h x 5.5d
FITMENT	56 LS
MSRP	\$634.15

**POWDER COAT COLORS:**



ANY STANDARD PRODUCT CAN BE CUSTOMIZED TO YOUR SPECIFIC NEEDS, PLEASE CALL 715-355-8842 AND TALK TO YOUR CTECH REPRESENTATIVE TODAY.

ENGINEERED TO FIT:

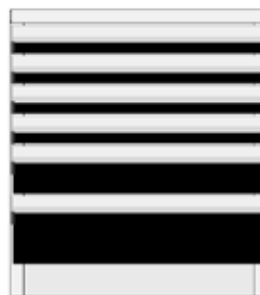
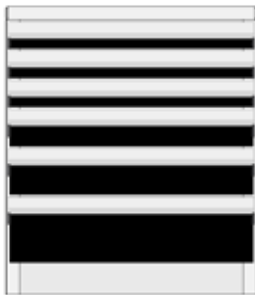
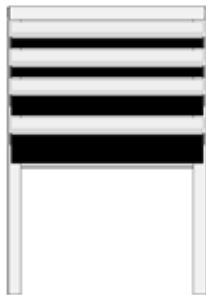
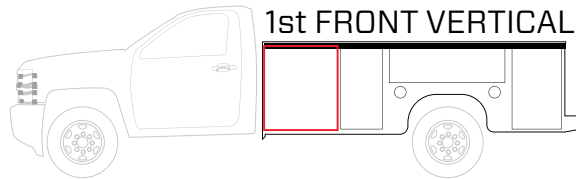

PRODUCT #:	550250
WIDTH	20.7"
HEIGHT	30"
DEPTH	12"
LOAD CAPACITY	250 lbs per drawer
DRAWERS	2-3", 1-4", 1-5"
SHELF TYPE	Telescoping
NOTCH	13.25"h x 4"d
FITMENT	MSS II Service 98, MSS II Top Pack 98
MSRP	\$761.56

PRODUCT #:	550253
WIDTH	25.7"
HEIGHT	29.613"
DEPTH	18"
LOAD CAPACITY	250 lbs per drawer
DRAWERS	3-3", 1-4", 1-5", 1-7"
SHELF TYPE	Telescoping
NOTCH	NA
FITMENT	MSS II Service 108, MSS II Top Pack 108
MSRP	\$1232.81

PRODUCT #:	550257
WIDTH	25.7"
HEIGHT	28.613"
DEPTH	18"
LOAD CAPACITY	250 lbs per drawer
DRAWERS	4-3", 1-5", 1-7"
SHELF TYPE	Telescoping
NOTCH	NA
FITMENT	MSS II Top Pack 132
MSRP	\$1458.57

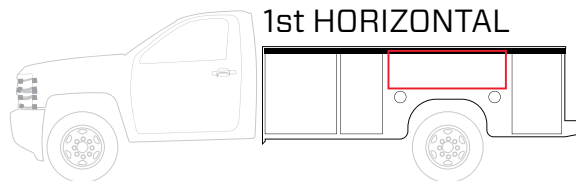

PRODUCT #:	550251
WIDTH	40"
HEIGHT	9.813"
DEPTH	12"
LOAD CAPACITY	250 lbs per drawer
DRAWERS	2-4"
SHELF TYPE	Telescoping
NOTCH	NA
FITMENT	MSS II Service 98
MSRP	\$683.45

PRODUCT #:	550256
WIDTH	40"
HEIGHT	7.813"
DEPTH	12"
LOAD CAPACITY	250 lbs per drawer
DRAWERS	2-3"
SHELF TYPE	Telescoping
NOTCH	NA
FITMENT	MSS II Top Pack 98
MSRP	\$624.91

PRODUCT #:	550258
WIDTH	40"
HEIGHT	9.813"
DEPTH	18"
LOAD CAPACITY	250 lbs per drawer
DRAWERS	2-4"
SHELF TYPE	Telescoping
NOTCH	NA
FITMENT	MSS II Service 108, 132
MSRP	\$790.71

PRODUCT #:	550259
WIDTH	40"
HEIGHT	7.813"
DEPTH	18"
LOAD CAPACITY	250 lbs per drawer
DRAWERS	2-3"
SHELF TYPE	Telescoping
NOTCH	11h x 3.5d
FITMENT	MSS II Top Pack 108, 132
MSRP	\$727.73

POWDER COAT COLORS:



ANY STANDARD PRODUCT CAN BE CUSTOMIZED TO YOUR SPECIFIC NEEDS, PLEASE CALL 715-355-8842 AND TALK TO YOUR CTECH REPRESENTATIVE TODAY.



ENGINEERED TO FIT:



CONTINUED...

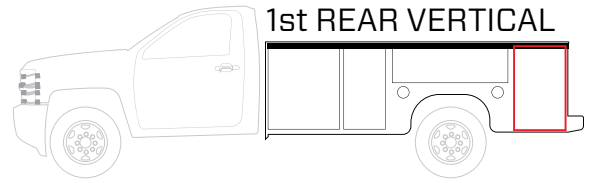

PRODUCT #:	550252
WIDTH	15.7"
HEIGHT	30"
DEPTH	12"
LOAD CAPACITY	250 lbs per drawer
DRAWERS	2-3", 1-4", 1-5"
SHELF TYPE	Telescoping
NOTCH	13.25"h x 4"d
FITMENT	MSS II Service 98, MSS II Top Pack 98
MSRP	<b>\$715.24</b>



PRODUCT #:	550255
WIDTH	15.7"
HEIGHT	29.613"
DEPTH	18"
LOAD CAPACITY	250 lbs per drawer
DRAWERS	3-3", 1-4", 1-5", 1-7"
SHELF TYPE	Telescoping
NOTCH	NA
FITMENT	MSS II Service 132, MSS II Top Pack 132
MSRP	<b>\$1085.56</b>



PRODUCT #:	550254
WIDTH	20.7"
HEIGHT	29.613"
DEPTH	18"
LOAD CAPACITY	250 lbs per drawer
DRAWERS	3-3", 1-4", 1-5", 1-7"
SHELF TYPE	Telescoping
NOTCH	NA
FITMENT	MSS II Service 108, 132, MSS II Top Pack 108, 132
MSRP	<b>\$1299.67</b>



DRAWERS

**POWDER COAT COLORS:**



ANY STANDARD PRODUCT CAN BE CUSTOMIZED TO YOUR SPECIFIC NEEDS, PLEASE CALL 715-355-8842 AND TALK TO YOUR CTECH REPRESENTATIVE TODAY.

ENGINEERED TO FIT:

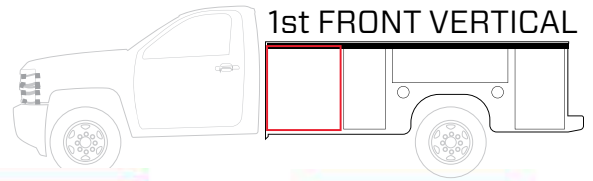

1st FRONT VERTICAL



PRODUCT #:	1402004
WIDTH	14.482"
HEIGHT	26.82"
DEPTH	14.5"
LOAD CAPACITY	250 lbs per drawer
DRAWERS	1-3", 4-4", 1-6"
SHELF TYPE	Telescoping
NOTCH	17.25"w x 4.5"d
FITMENT	SD SRW
MSRP	\$1019.13

PRODUCT #:	1402005
WIDTH	14.5"
HEIGHT	26.82"
DEPTH	18.5"
LOAD CAPACITY	250 lbs per drawer
DRAWERS	1-3", 4-4", 1-6"
SHELF TYPE	Telescoping
NOTCH	17.25"w x 11.671"d
FITMENT	SD DRW
MSRP	\$1114.59

PRODUCT #:	1402007
WIDTH	22"
HEIGHT	26.82"
DEPTH	14.5"
LOAD CAPACITY	250 lbs per drawer
DRAWERS	1-3", 4-4", 1-6"
SHELF TYPE	Telescoping
NOTCH	17.53"w x 7.671"d
FITMENT	SC 8'6", SC 9'4"
MSRP	\$1185.55

PRODUCT #:	1402008
WIDTH	22"
HEIGHT	26.82"
DEPTH	18.5"
LOAD CAPACITY	250 lbs per drawer
DRAWERS	1-3", 4-4", 1-6"
SHELF TYPE	Telescoping
NOTCH	17.53"w x 11.671"d
FITMENT	SC 8'6", SC 9'4", SC 11'4"
MSRP	\$1299.67

2nd FRONT VERTICAL

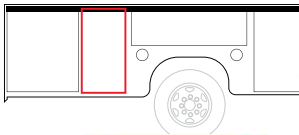

1st HORIZONTAL

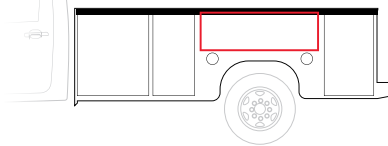

1st REAR VERTICAL

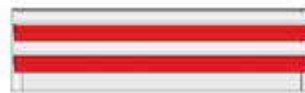
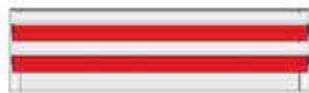
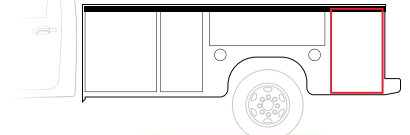

PRODUCT #:	1402009
WIDTH	16"
HEIGHT	26.82"
DEPTH	18.5"
LOAD CAPACITY	250 lbs per drawer
DRAWERS	1-3", 4-4", 1-6"
SHELF TYPE	Telescoping
NOTCH	11.53"w x 11.671"d
FITMENT	SC 11'4"
MSRP	\$1151.60

PRODUCT #:	1402010
WIDTH	39"
HEIGHT	10.62"
DEPTH	14.5"
LOAD CAPACITY	250 lbs per drawer
DRAWERS	2-4"
SHELF TYPE	Telescoping
NOTCH	NA
FITMENT	SC 8'4", SC 8'6", SC 9'4"
MSRP	\$661.41

PRODUCT #:	1402011
WIDTH	39"
HEIGHT	10.62"
DEPTH	18.5"
LOAD CAPACITY	250 lbs per drawer
DRAWERS	2-4"
SHELF TYPE	Telescoping
NOTCH	NA
FITMENT	SC 8'6", SC 9'4", SC 11'4"
MSRP	\$725.40

PRODUCT #:	1402015
WIDTH	17.75"
HEIGHT	26.82"
DEPTH	18.5"
LOAD CAPACITY	250 lbs per drawer
DRAWERS	1-3", 4-4", 1-6"
SHELF TYPE	Telescoping
NOTCH	17.9"h x 4.5"d
FITMENT	SC 9'4", SC 11'4"
MSRP	\$1194.79

POWDER COAT COLORS:



ANY STANDARD PRODUCT CAN BE CUSTOMIZED TO YOUR SPECIFIC NEEDS, PLEASE CALL 715-355-8842 AND TALK TO YOUR CTECH REPRESENTATIVE TODAY.

DRAWERS



ENGINEERED TO FIT:

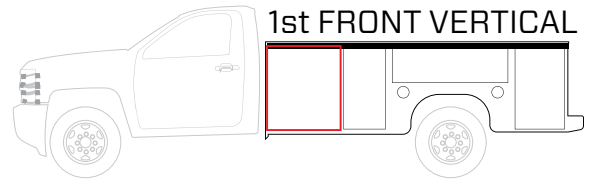

PRODUCT #:	522108
WIDTH	28"
HEIGHT	34.82"
DEPTH	18"
LOAD CAPACITY	250 lbs per drawer
DRAWERS	3-3", 1-4", 1-5", 1-6", 1-7"
SHELF TYPE	Telescoping
NOTCH	NA
FITMENT	Pal Pro 43CSR, Pal Pro 72
MSRP	\$1609.92

PRODUCT #:	522109
WIDTH	16"
HEIGHT	34.82"
DEPTH	18"
LOAD CAPACITY	250 lbs per drawer
DRAWERS	3-3", 1-4", 1-5", 1-6", 1-7"
SHELF TYPE	Telescoping
NOTCH	NA
FITMENT	Pal Pro 43, 72
MSRP	\$1259.47

PRODUCT #:	522113
WIDTH	28"
HEIGHT	43.82"
DEPTH	18"
LOAD CAPACITY	250 lbs per drawer
DRAWERS	3-3", 2-4", 2-5", 1-6", 1-7"
SHELF TYPE	Telescoping
NOTCH	NA
FITMENT	Pal Pro 72
MSRP	\$1999.96

PRODUCT #:	522125
WIDTH	28"
HEIGHT	26.82"
DEPTH	18"
LOAD CAPACITY	250 lbs per drawer
DRAWERS	2-3", 1-5", 1-7"
SHELF TYPE	Telescoping
NOTCH	NA
FITMENT	Pal Pro 43, 72
MSRP	\$1251.76



PRODUCT #:	522133
WIDTH	26"
HEIGHT	31.5"
DEPTH	17"
LOAD CAPACITY	250 lbs per drawer
DRAWERS	2-3", 1-4", 1-5", 1-6", 1-7"
SHELF TYPE	Telescoping
NOTCH	15.125"h x 2.125"d
FITMENT	108 DV
MSRP	\$1360.34

PRODUCT #:	522134
WIDTH	26"
HEIGHT	26.5"
DEPTH	17"
LOAD CAPACITY	250 lbs per drawer
DRAWERS	2-3", 2-5", 1-7"
SHELF TYPE	Telescoping
NOTCH	15.125"h x 2.125"d
FITMENT	108 DV
MSRP	\$1172.85

PRODUCT #:	522135
WIDTH	26"
HEIGHT	32.5"
DEPTH	17"
LOAD CAPACITY	250 lbs per drawer
DRAWERS	4-3", 2-5", 1-7"
SHELF TYPE	Telescoping
NOTCH	15.125"h x 2.125"d
FITMENT	108 DV
MSRP	\$1464.92

PRODUCT #:	522140
WIDTH	27"
HEIGHT	31.5"
DEPTH	17"
LOAD CAPACITY	250 lbs per drawer
DRAWERS	2-3", 1-4" 1-5", 1-6", 1-7"
SHELF TYPE	Telescoping
NOTCH	15.125"h x 2.125"d
FITMENT	132 DV
MSRP	\$1385.68

POWDER COAT COLORS:



ANY STANDARD PRODUCT CAN BE CUSTOMIZED TO YOUR SPECIFIC NEEDS, PLEASE CALL 715-355-8842 AND TALK TO YOUR CTECH REPRESENTATIVE TODAY.

ENGINEERED TO FIT:

CONTINUED...

# PALFINGER

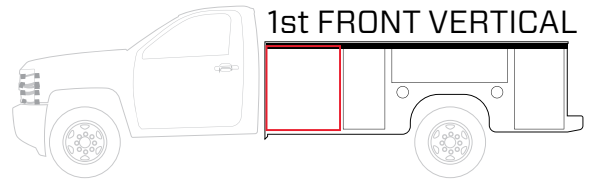

PRODUCT #:	522141
WIDTH	27"
HEIGHT	26.5"
DEPTH	17"
LOAD CAPACITY	250 lbs per drawer
DRAWERS	2-3", 2-5", 1-7"
SHELF TYPE	Telescoping
NOTCH	15.125"h x 2.125"d
FITMENT	132 DV
MSRP	\$1194.30



PRODUCT #:	522144
WIDTH	22"
HEIGHT	28.5"
DEPTH	12"
LOAD CAPACITY	250 lbs per drawer
DRAWERS	4-3"
SHELF TYPE	Telescoping
NOTCH	12.125h x 4.125d
FITMENT	96 V
MSRP	\$751.54



PRODUCT #:	522145
WIDTH	22"
HEIGHT	27.5"
DEPTH	12"
LOAD CAPACITY	250 lbs per drawer
DRAWERS	2-3", 1-5"
SHELF TYPE	Telescoping
NOTCH	12.125h x 4.125d
FITMENT	96 V
MSRP	\$674.18

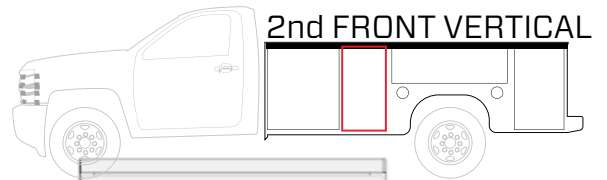

PRODUCT #:	522109
WIDTH	16"
HEIGHT	34.82"
DEPTH	18"
LOAD CAPACITY	250 lbs per drawer
DRAWERS	3-3", 1-4", 1-5", 1-6", 1-7"
SHELF TYPE	Telescoping
NOTCH	NA
FITMENT	Pal Pro 43, 72
MSRP	\$1259.47



PRODUCT #:	522142
WIDTH	17"
HEIGHT	31.5"
DEPTH	17"
LOAD CAPACITY	250 lbs per drawer
DRAWERS	2-3", 1-4", 1-5", 1-6", 1-7"
SHELF TYPE	Telescoping
NOTCH	NA
FITMENT	132 DV
MSRP	\$1132.33



PRODUCT #:	522114
WIDTH	16"
HEIGHT	43.82"
DEPTH	18"
LOAD CAPACITY	250 lbs per drawer
DRAWERS	3-3", 2-4", 2-5", 1-6", 1-7"
SHELF TYPE	Telescoping
NOTCH	NA
FITMENT	Pal Pro 43, 72
MSRP	\$1558.84

DRAWERS

**POWDER COAT COLORS:**



ANY STANDARD PRODUCT CAN BE CUSTOMIZED TO YOUR SPECIFIC NEEDS, PLEASE CALL 715-355-8842 AND TALK TO YOUR CTECH REPRESENTATIVE TODAY.



ENGINEERED TO FIT:

CONTINUED...

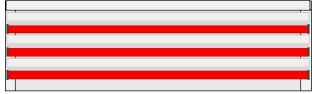
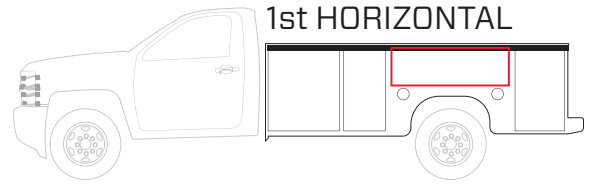

PRODUCT #:	522102
WIDTH	40"
HEIGHT	11.82"
DEPTH	12"
LOAD CAPACITY	250 lbs per drawer
DRAWERS	3-3
SHELF TYPE	Telescoping
NOTCH	NA
FITMENT	96 V
MSRP	\$751.88



PRODUCT #:	522143
WIDTH	47"
HEIGHT	11.82"
DEPTH	18"
LOAD CAPACITY	250 lbs per drawer
DRAWERS	3-3"
SHELF TYPE	Telescoping
NOTCH	NA
FITMENT	Pal Pro 43
MSRP	\$971.18



PRODUCT #:	522115
WIDTH	45"
HEIGHT	14.32"
DEPTH	18"
LOAD CAPACITY	250 lbs per drawer
DRAWERS	4-3"
SHELF TYPE	Telescoping
NOTCH	NA
FITMENT	Pal Pro 72
MSRP	\$1158.54



PRODUCT #:	522116
WIDTH	45"
HEIGHT	17.82"
DEPTH	18"
LOAD CAPACITY	250 lbs per drawer
DRAWERS	5-3"
SHELF TYPE	Telescoping
NOTCH	NA
FITMENT	Pal Pro 72
MSRP	\$1370.17

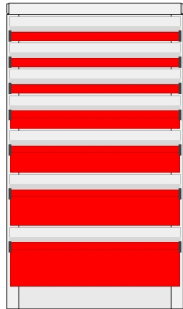
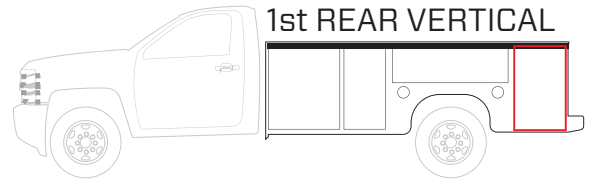

PRODUCT #:	522112
WIDTH	20"
HEIGHT	34.82"
DEPTH	18"
LOAD CAPACITY	250 lbs per drawer
DRAWERS	3-3", 1-4", 1-5", 1-6", 1-7"
SHELF TYPE	Telescoping
NOTCH	NA
FITMENT	Pal Pro 43
MSRP	\$1376.28

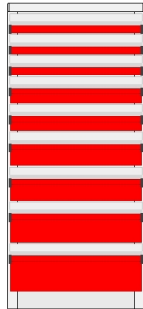

PRODUCT #:	522117
WIDTH	19.5"
HEIGHT	43.82"
DEPTH	18"
LOAD CAPACITY	250 lbs per drawer
DRAWERS	3-3", 2-4", 2-5", 1-6", 1-7"
SHELF TYPE	Telescoping
NOTCH	NA
FITMENT	Pal Pro 72
MSRP	\$1687.50



PRODUCT #:	522126
WIDTH	19.5"
HEIGHT	29.82"
DEPTH	18"
LOAD CAPACITY	250 lbs per drawer
DRAWERS	3-3", 2-5", 1-7"
SHELF TYPE	Telescoping
NOTCH	NA
FITMENT	Pal Pro 43, 72
MSRP	\$1194.48

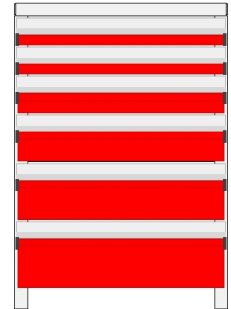

PRODUCT #:	522138
WIDTH	22"
HEIGHT	31.5"
DEPTH	17"
LOAD CAPACITY	250 lbs per drawer
DRAWERS	2-3", 1-4", 1-5", 1-6", 1-7"
SHELF TYPE	Telescoping
NOTCH	12.125"h x 2.125"d
FITMENT	108 DV, 132 DV
MSRP	\$1259.00

POWDER COAT COLORS:



ANY STANDARD PRODUCT CAN BE CUSTOMIZED TO YOUR SPECIFIC NEEDS, PLEASE CALL 715-355-8842 AND TALK TO YOUR CTECH REPRESENTATIVE TODAY.

DRAWERS

ENGINEERED TO FIT:

# R ROYAL TRUCK BODY

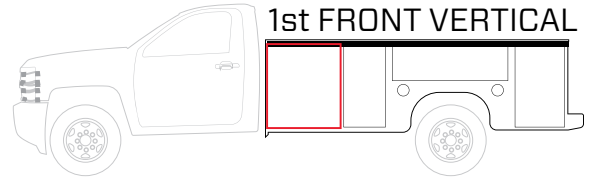

1st FRONT VERTICAL



PRODUCT #:	63710-030
WIDTH	20"
HEIGHT	29.82"
DEPTH	16"
LOAD CAPACITY	250 lbs per drawer
DRAWERS	4-3", 1-5", 1-7"
SHELF TYPE	Telescoping
NOTCH	NA
FITMENT	XPRS-11
MSRP	\$1130.52

PRODUCT #:	63710-005
WIDTH	25"
HEIGHT	29.82"
DEPTH	12"
LOAD CAPACITY	250 lbs per drawer
DRAWERS	4-3", 1-5", 1-7"
SHELF TYPE	Telescoping
NOTCH	NA
FITMENT	40-V0-108
MSRP	\$1122.28

PRODUCT #:	63710-007
WIDTH	25"
HEIGHT	29.82"
DEPTH	16"
LOAD CAPACITY	250 lbs per drawer
DRAWERS	4-3", 1-5", 1-7"
SHELF TYPE	Telescoping
NOTCH	NA
FITMENT	40-V00-125
MSRP	\$1247.07

PRODUCT #:	63710-009
WIDTH	25"
HEIGHT	29.82"
DEPTH	19"
LOAD CAPACITY	250 lbs per drawer
DRAWERS	4-3", 1-5", 1-7"
SHELF TYPE	Telescoping
NOTCH	NA
FITMENT	40-V00-132
MSRP	\$1335.05

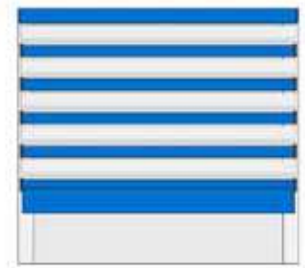
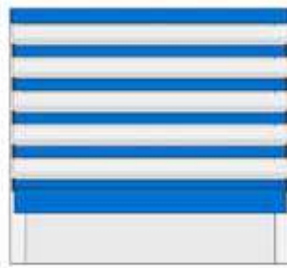
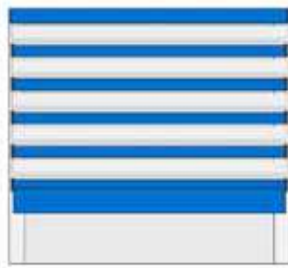

PRODUCT #:	63710-021
WIDTH	25"
HEIGHT	22.82"
DEPTH	12"
LOAD CAPACITY	250 lbs per drawer
DRAWERS	2-3", 1-4"
SHELF TYPE	Telescoping
NOTCH	11h x 3.5d
FITMENT	33-V0-98
MSRP	\$684.41

PRODUCT #:	63710-025
WIDTH	25"
HEIGHT	22.82"
DEPTH	12"
LOAD CAPACITY	250 lbs per drawer
DRAWERS	4-3", 1-5"
SHELF TYPE	Telescoping
NOTCH	NA
FITMENT	33-V0-108
MSRP	\$920.64

PRODUCT #:	63710-027
WIDTH	25"
HEIGHT	22.82"
DEPTH	16"
LOAD CAPACITY	250 lbs per drawer
DRAWERS	4-3", 1-5"
SHELF TYPE	Telescoping
NOTCH	NA
FITMENT	33-V0-125
MSRP	\$1023.10

PRODUCT #:	63710-029
WIDTH	25"
HEIGHT	22.82"
DEPTH	19"
LOAD CAPACITY	250 lbs per drawer
DRAWERS	4-3", 1-5"
SHELF TYPE	Telescoping
NOTCH	NA
FITMENT	33-V00-132
MSRP	\$1095.27

DRAWERS

**POWDER COAT COLORS:**



ANY STANDARD PRODUCT CAN BE CUSTOMIZED TO YOUR SPECIFIC NEEDS, PLEASE CALL 715-355-8842 AND TALK TO YOUR CTECH REPRESENTATIVE TODAY.



ENGINEERED TO FIT:

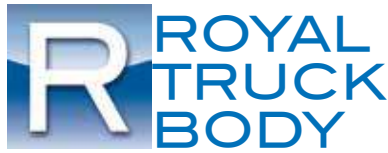

CONTINUED...

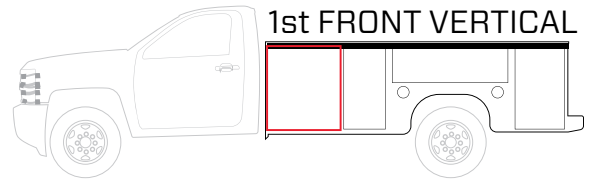

PRODUCT #:	63710-011
WIDTH	25"
HEIGHT	46"
DEPTH	12"
LOAD CAPACITY	250 lbs per drawer
DRAWERS	4-3", 1-4", 2-5", 1-7"
SHELF TYPE	Telescoping
NOTCH	11h x 3.5d
FITMENT	56-V0-98
MSRP	\$1471.21

PRODUCT #:	63710-013
WIDTH	25"
HEIGHT	45.82"
DEPTH	19"
LOAD CAPACITY	250 lbs per drawer
DRAWERS	4-3", 1-4", 2-5", 2-7"
SHELF TYPE	Telescoping
NOTCH	11h x 3.5d
FITMENT	56-V00-98
MSRP	\$1948.95

PRODUCT #:	63710-015
WIDTH	25"
HEIGHT	45.82"
DEPTH	12"
LOAD CAPACITY	250 lbs per drawer
DRAWERS	4-3", 1-4", 2-5", 2-7"
SHELF TYPE	Telescoping
NOTCH	NA
FITMENT	56-V0-108
MSRP	\$1639.58

PRODUCT #:	63710-017
WIDTH	25"
HEIGHT	45.82"
DEPTH	16"
LOAD CAPACITY	250 lbs per drawer
DRAWERS	4-3", 1-4", 2-5", 2-7"
SHELF TYPE	Telescoping
NOTCH	NA
FITMENT	56-V00-125
MSRP	\$1821.17

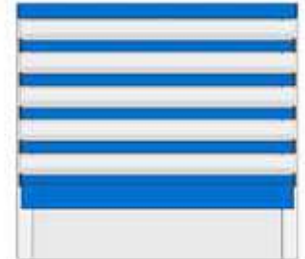
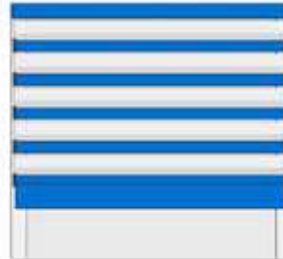
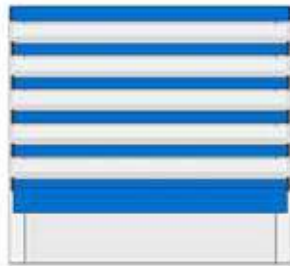

PRODUCT #:	63710-019
WIDTH	25"
HEIGHT	45.82"
DEPTH	19"
LOAD CAPACITY	250 lbs per drawer
DRAWERS	4-3", 1-4", 2-5", 2-7"
SHELF TYPE	Telescoping
NOTCH	NA
FITMENT	56-V00-132
MSRP	\$1948.95

PRODUCT #:	63710-023
WIDTH	25"
HEIGHT	22.82"
DEPTH	19"
LOAD CAPACITY	250 lbs per drawer
DRAWERS	4-3", 1-5"
SHELF TYPE	Telescoping
NOTCH	11h x 3.5d
FITMENT	33-V00-98
MSRP	\$1095.27

PRODUCT #:	63710-001
WIDTH	25"
HEIGHT	30"
DEPTH	12"
LOAD CAPACITY	250 lbs per drawer
DRAWERS	4-3", 1-5"
SHELF TYPE	Telescoping
NOTCH	11h x 3.5d
FITMENT	40-V0-98
MSRP	\$953.91

PRODUCT #:	63710-003
WIDTH	25"
HEIGHT	29.82"
DEPTH	19"
LOAD CAPACITY	250 lbs per drawer
DRAWERS	1-3", 1-4", 2-5", 1-7"
SHELF TYPE	Telescoping
NOTCH	11h x 3.5d
FITMENT	40-V00-98
MSRP	\$1257.89

POWDER COAT COLORS:



ANY STANDARD PRODUCT CAN BE CUSTOMIZED TO YOUR SPECIFIC NEEDS, PLEASE CALL 715-355-8842 AND TALK TO YOUR CTECH REPRESENTATIVE TODAY.

ENGINEERED TO FIT:

# R ROYAL TRUCK BODY

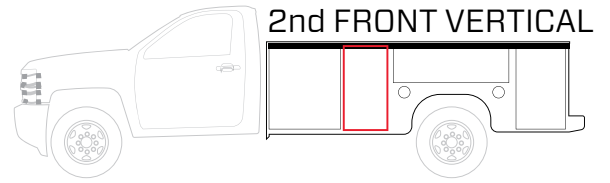

PRODUCT #:	63710-006
WIDTH	17"
HEIGHT	29.82"
DEPTH	16"
LOAD CAPACITY	250 lbs per drawer
DRAWERS	4-3", 1-5", 1-7"
SHELF TYPE	Telescoping
NOTCH	NA
FITMENT	40-VDO-125
MSRP	\$1060.59

PRODUCT #:	63710-008
WIDTH	17"
HEIGHT	29.82"
DEPTH	19"
LOAD CAPACITY	250 lbs per drawer
DRAWERS	4-3", 1-5", 1-7"
SHELF TYPE	Telescoping
NOTCH	NA
FITMENT	40-VDO-132
MSRP	\$1133.05

PRODUCT #:	63710-016
WIDTH	17"
HEIGHT	45.82"
DEPTH	16"
LOAD CAPACITY	250 lbs per drawer
DRAWERS	4-3", 1-4", 2-5", 2-7"
SHELF TYPE	Telescoping
NOTCH	NA
FITMENT	56-VDO-125
MSRP	\$1537.87



PRODUCT #:	63710-018
WIDTH	17"
HEIGHT	45.82"
DEPTH	19"
LOAD CAPACITY	250 lbs per drawer
DRAWERS	4-3", 1-4", 2-5", 2-7"
SHELF TYPE	Telescoping
NOTCH	NA
FITMENT	56-VDO-132
MSRP	\$1643.59

PRODUCT #:	63710-026
WIDTH	17"
HEIGHT	22.82"
DEPTH	16"
LOAD CAPACITY	250 lbs per drawer
DRAWERS	4-3", 1-5"
SHELF TYPE	Telescoping
NOTCH	NA
FITMENT	33-VDO-125
MSRP	\$875.79

PRODUCT #:	63710-028
WIDTH	17"
HEIGHT	22.82"
DEPTH	19"
LOAD CAPACITY	250 lbs per drawer
DRAWERS	4-3", 1-5"
SHELF TYPE	Telescoping
NOTCH	NA
FITMENT	33-VDO-132
MSRP	\$934.80

**POWDER COAT COLORS:**



ANY STANDARD PRODUCT CAN BE CUSTOMIZED TO YOUR SPECIFIC NEEDS, PLEASE CALL 715-355-8842 AND TALK TO YOUR CTECH REPRESENTATIVE TODAY.

DRAWERS



ENGINEERED TO FIT:

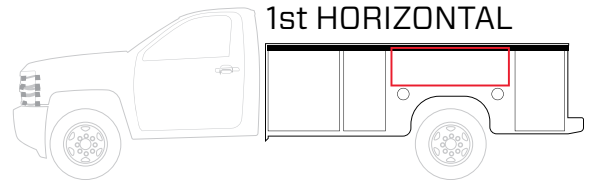
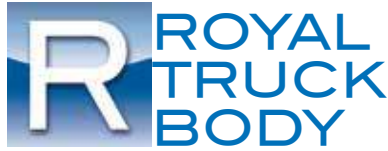

PRODUCT #:	63710-032
WIDTH	32"
HEIGHT	10.625"
DEPTH	12"
LOAD CAPACITY	250 lbs per drawer
DRAWERS	2-4"
SHELF TYPE	Telescoping
NOTCH	NA
FITMENT	40-V0-98
MSRP	\$567.72

PRODUCT #:	63710-033
WIDTH	32"
HEIGHT	10.625"
DEPTH	19"
LOAD CAPACITY	250 lbs per drawer
DRAWERS	2-4"
SHELF TYPE	Telescoping
NOTCH	NA
FITMENT	40-V00-98
MSRP	\$664.69

PRODUCT #:	63710-034
WIDTH	42"
HEIGHT	10.625"
DEPTH	12"
LOAD CAPACITY	250 lbs per drawer
DRAWERS	2-4"
SHELF TYPE	Telescoping
NOTCH	NA
FITMENT	40-V0-108
MSRP	\$645.80

PRODUCT #:	63710-035
WIDTH	35"
HEIGHT	10.625"
DEPTH	16"
LOAD CAPACITY	250 lbs per drawer
DRAWERS	2-4"
SHELF TYPE	Telescoping
NOTCH	NA
FITMENT	40-V00-125
MSRP	\$650.85



PRODUCT #:	63710-036
WIDTH	42"
HEIGHT	10.625"
DEPTH	19"
LOAD CAPACITY	250 lbs per drawer
DRAWERS	2-4"
SHELF TYPE	Telescoping
NOTCH	NA
FITMENT	40-V00-132
MSRP	\$761.56

PRODUCT #:	63710-037
WIDTH	32"
HEIGHT	26.625"
DEPTH	12"
LOAD CAPACITY	250 lbs per drawer
DRAWERS	3-3", 3-5"
SHELF TYPE	Telescoping
NOTCH	NA
FITMENT	56-V0-98
MSRP	\$1232.81

PRODUCT #:	63710-038
WIDTH	32"
HEIGHT	26.625"
DEPTH	19"
LOAD CAPACITY	250 lbs per drawer
DRAWERS	3-3", 3-5"
SHELF TYPE	Telescoping
NOTCH	NA
FITMENT	56-V00-98
MSRP	\$1458.57

POWDER COAT COLORS:



ANY STANDARD PRODUCT CAN BE CUSTOMIZED TO YOUR SPECIFIC NEEDS, PLEASE CALL 715-355-8842 AND TALK TO YOUR CTECH REPRESENTATIVE TODAY.

DRAWERS

ENGINEERED TO FIT:

# R ROYAL TRUCK BODY

CONTINUED...

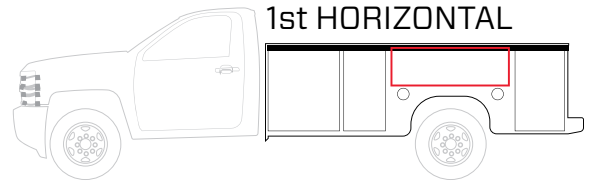

1st HORIZONTAL



PRODUCT #:	63710-039
WIDTH	42"
HEIGHT	26.625"
DEPTH	12"
LOAD CAPACITY	250 lbs per drawer
DRAWERS	3-3", 3-5"
SHELF TYPE	Telescoping
NOTCH	NA
FITMENT	56-V0-108
MSRP	\$1433.42

PRODUCT #:	63710-040
WIDTH	35"
HEIGHT	26.625"
DEPTH	16"
LOAD CAPACITY	250 lbs per drawer
DRAWERS	3-3", 3-5"
SHELF TYPE	Telescoping
NOTCH	NA
FITMENT	56-V00-125
MSRP	\$1432.61

PRODUCT #:	63710-041
WIDTH	42"
HEIGHT	26.625"
DEPTH	19"
LOAD CAPACITY	250 lbs per drawer
DRAWERS	3-3", 3-5"
SHELF TYPE	Telescoping
NOTCH	NA
FITMENT	56-V00-132
MSRP	\$1702.35

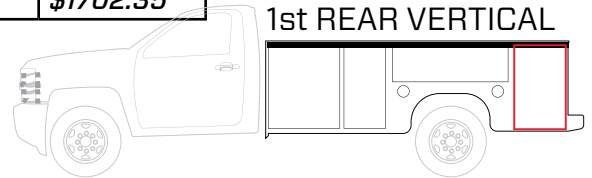

1st REAR VERTICAL



PRODUCT #:	63710-004
WIDTH	17"
HEIGHT	29.82"
DEPTH	12"
LOAD CAPACITY	250 lbs per drawer
DRAWERS	4-3", 1-5", 1-7"
SHELF TYPE	Telescoping
NOTCH	NA
FITMENT	40-V0-108
MSRP	\$956.50

PRODUCT #:	63710-024
WIDTH	17"
HEIGHT	22.82"
DEPTH	12"
LOAD CAPACITY	250 lbs per drawer
DRAWERS	4-3", 1-5"
SHELF TYPE	Telescoping
NOTCH	NA
FITMENT	33-V0-108
MSRP	\$790.88

PRODUCT #:	63710-014
WIDTH	17"
HEIGHT	22.82"
DEPTH	12"
LOAD CAPACITY	250 lbs per drawer
DRAWERS	4-3", 1-4", 2-5", 2-7"
SHELF TYPE	Telescoping
NOTCH	NA
FITMENT	56-V00-108
MSRP	\$1385.68

PRODUCT #:	63710-020
WIDTH	17"
HEIGHT	22.82"
DEPTH	12"
LOAD CAPACITY	250 lbs per drawer
DRAWERS	2-3", 1-4"
SHELF TYPE	Telescoping
NOTCH	11h x 3.5d
FITMENT	33-V0-98 33-V0-108 SS
MSRP	\$596.76

**POWDER COAT COLORS:**



ANY STANDARD PRODUCT CAN BE CUSTOMIZED TO YOUR SPECIFIC NEEDS, PLEASE CALL 715-355-8842 AND TALK TO YOUR CTECH REPRESENTATIVE TODAY.

DRAWERS



ENGINEERED TO FIT:

# R ROYAL TRUCK BODY

CONTINUED...

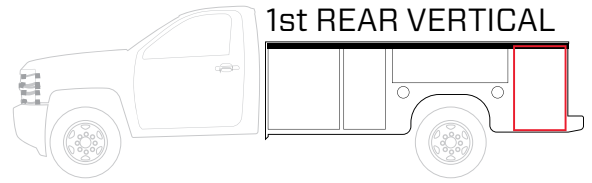

PRODUCT #:	63710-022
WIDTH	17"
HEIGHT	22.82"
DEPTH	19"
LOAD CAPACITY	250 lbs per drawer
DRAWERS	4-3", 1-5"
SHELF TYPE	Telescoping
NOTCH	11h x 3.5d
FITMENT	33-V0-98 33-V0-108 SS
MSRP	<b>\$934.80</b>

PRODUCT #:	63710-000
WIDTH	17"
HEIGHT	30"
DEPTH	12"
LOAD CAPACITY	250 lbs per drawer
DRAWERS	4-3", 1-5"
SHELF TYPE	Telescoping
NOTCH	11h x 3.5d
FITMENT	40-V0-98 40-V0-108 SS
MSRP	<b>\$820.22</b>

PRODUCT #:	63710-002
WIDTH	17"
HEIGHT	29.82"
DEPTH	19"
LOAD CAPACITY	250 lbs per drawer
DRAWERS	1-3", 1-4", 2-5", 1-7"
SHELF TYPE	Telescoping
NOTCH	11h x 3.5d
FITMENT	40-V0-98 40-V0-108 SS
MSRP	<b>\$1072.97</b>

PRODUCT #:	63710-010
WIDTH	17"
HEIGHT	46"
DEPTH	12"
LOAD CAPACITY	250 lbs per drawer
DRAWERS	4-3", 1-4", 2-5", 1-7"
SHELF TYPE	Telescoping
NOTCH	11h x 3.5d
FITMENT	56-V0-98 56-V0-108 SS
MSRP	<b>\$1249.41</b>



PRODUCT #:	63710-006
WIDTH	17"
HEIGHT	29.82"
DEPTH	16"
LOAD CAPACITY	250 lbs per drawer
DRAWERS	4-3", 1-5", 1-7"
SHELF TYPE	Telescoping
NOTCH	NA
FITMENT	0-V00-125
MSRP	<b>\$1060.59</b>

PRODUCT #:	63710-008
WIDTH	17"
HEIGHT	29.82"
DEPTH	19"
LOAD CAPACITY	250 lbs per drawer
DRAWERS	4-3", 1-5", 1-7"
SHELF TYPE	Telescoping
NOTCH	NA
FITMENT	40-V00-132
MSRP	<b>\$1133.05</b>

PRODUCT #:	63710-016
WIDTH	17"
HEIGHT	45.82"
DEPTH	16"
LOAD CAPACITY	250 lbs per drawer
DRAWERS	1-3", 1-4", 2-5", 1-7"
SHELF TYPE	Telescoping
NOTCH	NA
FITMENT	56-V00-125
MSRP	<b>\$1537.87</b>

**POWDER COAT COLORS:**



ANY STANDARD PRODUCT CAN BE CUSTOMIZED TO YOUR SPECIFIC NEEDS, PLEASE CALL 715-355-8842 AND TALK TO YOUR CTECH REPRESENTATIVE TODAY.

ENGINEERED TO FIT:

# R ROYAL TRUCK BODY

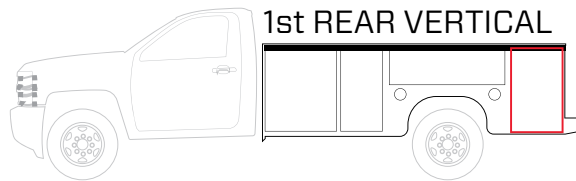

CONTINUED...



PRODUCT #:	63710-018
WIDTH	17"
HEIGHT	45.82"
DEPTH	19"
LOAD CAPACITY	250 lbs per drawer
DRAWERS	4-3", 1-4", 2-5", 1-7"
SHELF TYPE	Telescoping
NOTCH	NA
FITMENT	56-V00-132
MSRP	\$1643.59

PRODUCT #:	63710-026
WIDTH	17"
HEIGHT	22.82"
DEPTH	16"
LOAD CAPACITY	250 lbs per drawer
DRAWERS	4-3", 1-5"
SHELF TYPE	Telescoping
NOTCH	NA
FITMENT	33-V00-125
MSRP	\$875.79

PRODUCT #:	63710-028
WIDTH	17"
HEIGHT	22.82"
DEPTH	19"
LOAD CAPACITY	250 lbs per drawer
DRAWERS	4-3", 1-5"
SHELF TYPE	Telescoping
NOTCH	NA
FITMENT	33-V00-132
MSRP	\$934.80

**POWDER COAT COLORS:**



ANY STANDARD PRODUCT CAN BE CUSTOMIZED TO YOUR SPECIFIC NEEDS, PLEASE CALL 715-355-8842 AND TALK TO YOUR CTECH REPRESENTATIVE TODAY.

*\*MORE MANUFACTURERS AVAILABLE: Upon request we can supply standard units for most truck bodies*

DRAWERS







PRODUCT #:	BB201
WIDTH	14.37"
HEIGHT	7.643"
DEPTH	17.5"
LOAD CAPACITY	
BOLT BINS	2 Bins, 2 Columns, 1 Row
SHELF TYPE	Telescoping
NOTCH	NA
FITMENT	Universal
MSRP	<b>\$327.14</b>

PRODUCT #:	BB301
WIDTH	19.932"
HEIGHT	7.643"
DEPTH	17.5"
LOAD CAPACITY	
BOLT BINS	3 Bins, 3 Columns, 1 Row
SHELF TYPE	Telescoping
NOTCH	NA
FITMENT	Universal
MSRP	<b>\$409.31</b>

PRODUCT #:	BB401
WIDTH	25.495"
HEIGHT	7.643"
DEPTH	17.5"
LOAD CAPACITY	
BOLT BINS	4 Bins, 4 Columns, 1 Row
SHELF TYPE	Telescoping
NOTCH	NA
FITMENT	Universal
MSRP	<b>\$491.48</b>

PRODUCT #:	BB501
WIDTH	31.057"
HEIGHT	7.643"
DEPTH	17.5"
LOAD CAPACITY	
BOLT BINS	5 Bins, 5 Columns, 1 Row
SHELF TYPE	Telescoping
NOTCH	NA
FITMENT	Universal
MSRP	<b>\$573.65</b>



Do you feel constricted by a limited number of "standard sized" bolt bins? CTech has made bolt bins configurable ask one of our authorized dealers for this instant pricing, sizing, and color options. Bolt bins are a universal fit product and the sizing is determined by the width and height of the individual bin.

How many Columns?



How many Rows?



Bottom Space = 2.5

## Smallest configured bolt bin.....

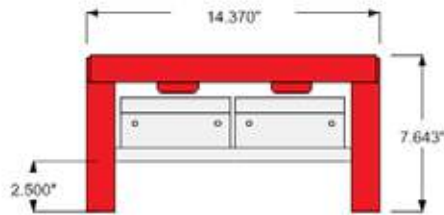

- Painted Shelf
- Painted Insert Sides

How many Columns?



How many Rows?



Bottom Space = 2.501

## ..... up to our Largest!

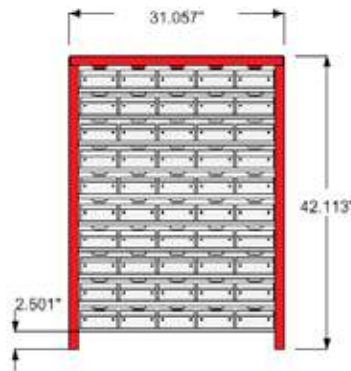

- Painted Shelf
- Painted Insert Sides

## and everything in between,

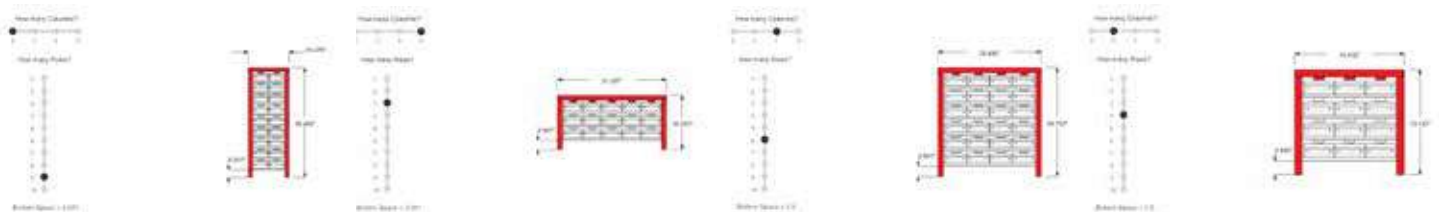

**ask CTech or your dealer today.**

### POWDER COAT COLORS:



ANY STANDARD PRODUCT CAN BE CUSTOMIZED TO YOUR SPECIFIC NEEDS, PLEASE CALL 715-355-8842 AND TALK TO YOUR CTECH REPRESENTATIVE TODAY.

DRAWERS



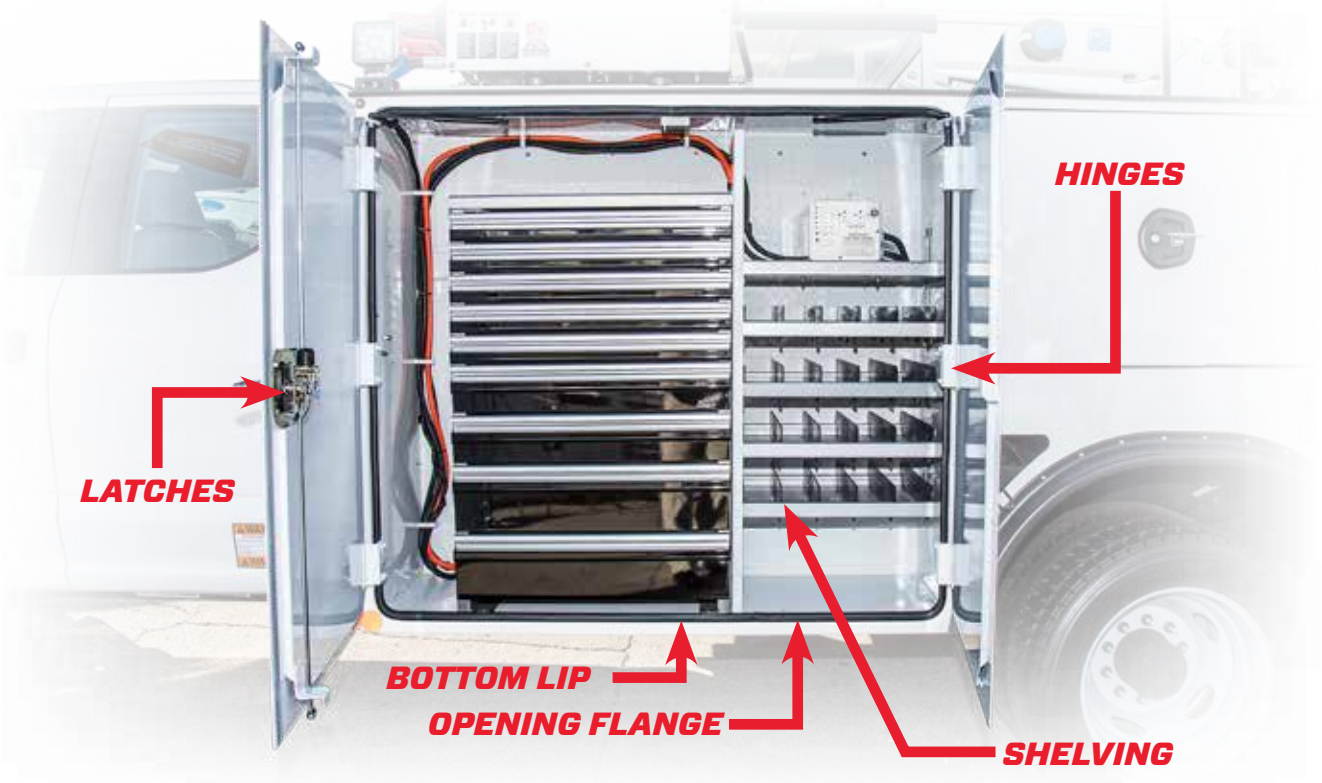

What type of obstruction affects your measurements?

**Height:**

- Opening Flange
- Bottom Lip
- Door Stay

**Width:**

- Opening Flange
- Hinge
- Latch

**Depth:**

- Opening Flange
- Hinge
- Latch
- Door Stay
- Notch (if present)

**SIDE**

**CUTAWAY - Front**

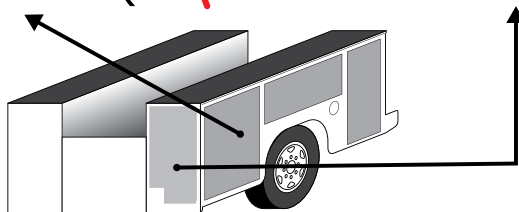
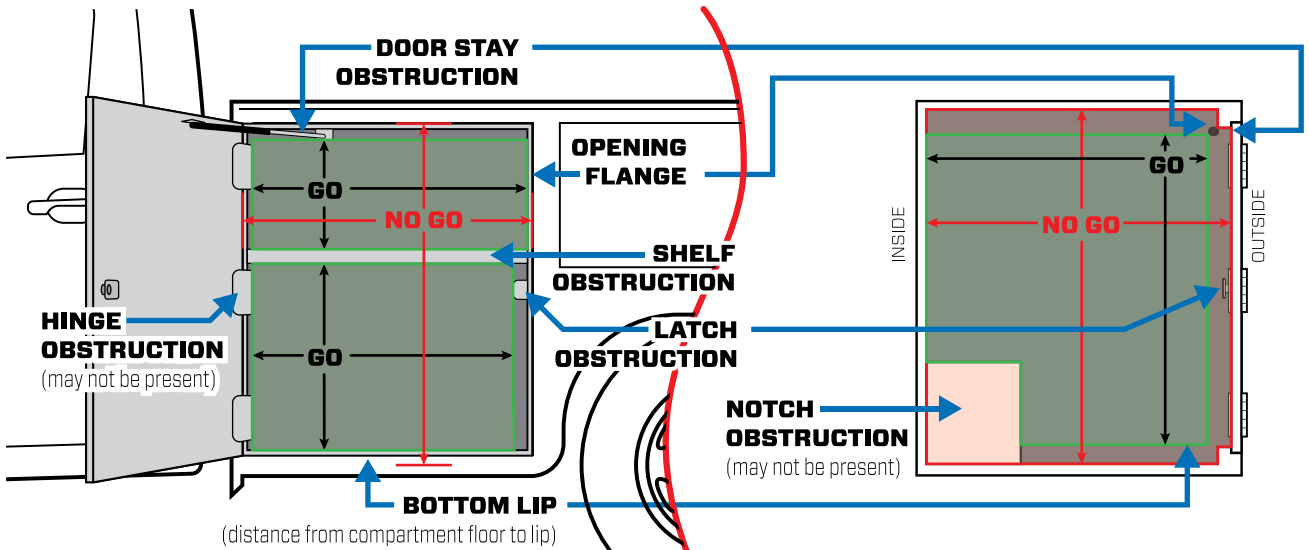





# DRAWER OPTIONS

ANY STANDARD PRODUCT CAN BE CUSTOMIZED TO YOUR SPECIFIC NEEDS. CHECK OUT OUR ONLINE DEALER MAP FOR YOUR LOCAL DEALER OR CONTACT US DIRECTLY.

**TOP STYLES:**

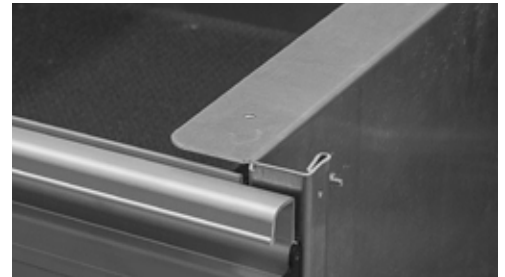
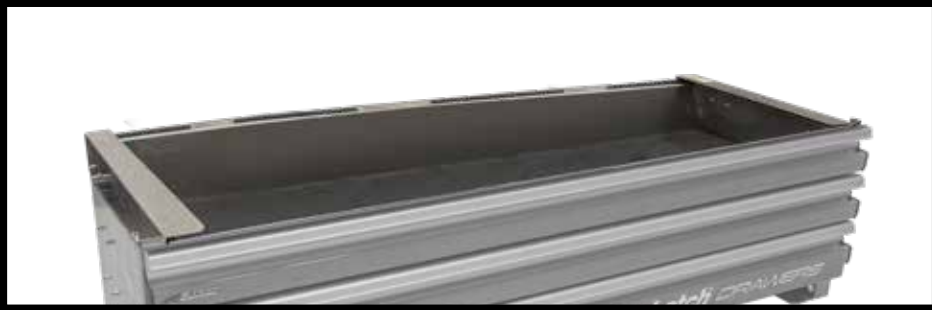

**None -**

With no top option you can extend the drawer unit to the top of a compartment if the clear opening allows for it.

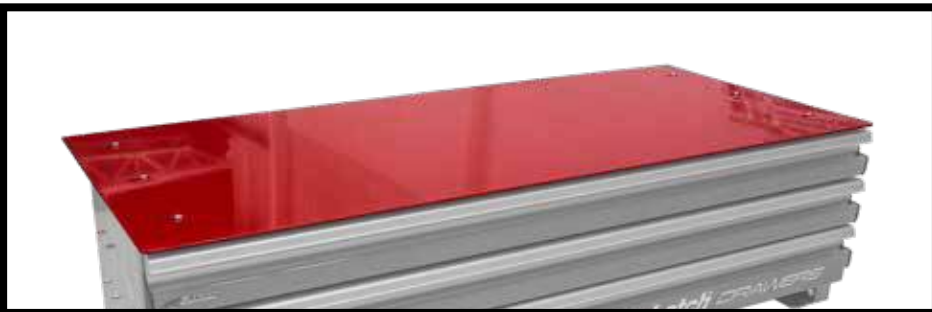

**Flat -**

Turns the top of any Tool Drawer Unit into a great work surface and gives a quality finished appearance when powder coated in the same color as the drawer faces. Height: 0.125"

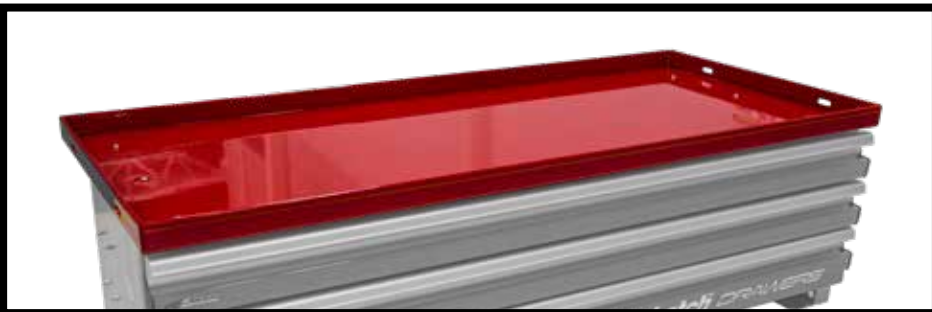

**Fixed Tray -**

Add another area of storage with the fixed top. Its design allows for a shallow tray that keeps items from rolling off the top. Powder coat finish is the same color as the drawer face. Height: 1.313"



**Adjustable Tray -**

Maintain the same storage benefits of the fixed tray and still have the adjustability to mount the adjustable wings to secure the tool drawer unit. Powder coat finish is the same color as the drawer face. Height: 1.313"

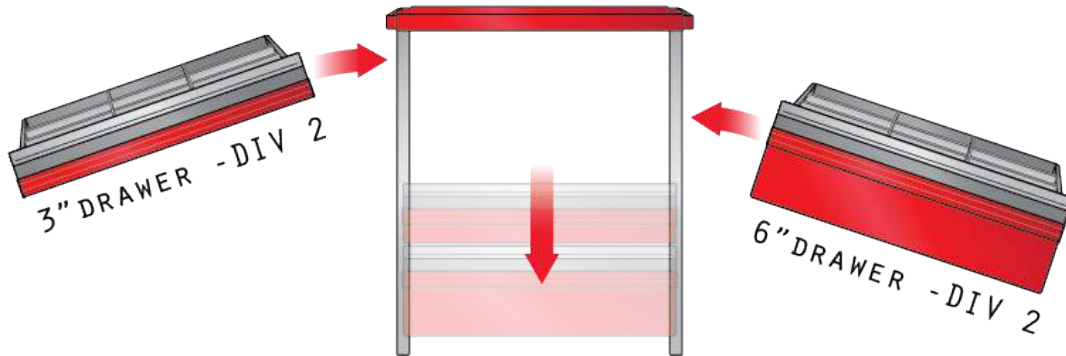
**CONFIGURE A CUSTOM DRAWER:**

Configure-

Build a unit that fits your needs perfectly. Contact your local dealer today.

\*Dealers - Use CTech Express to build a custom unit for an instant quote.

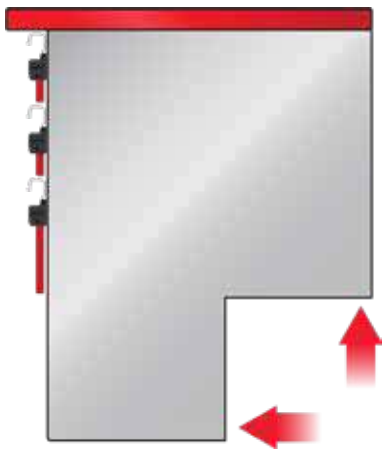
**CUSTOM NOTCHING:**

Notching-

Standard drawer units that require rear notching for a specific manufacturer truck body come with the correct notch size, but when building a custom unit, notching measurements are needed.

**DRAWER LOCKS: NEW FEATURE**

**NOW AVAILABLE!**

Security of your tools and supplies is important when your livelihood depends on them to perform your job. CTech has drawer lock options available for that added peace of mind.

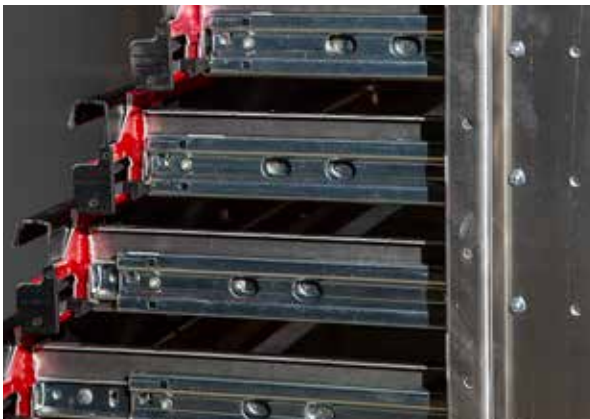
**SLIDE CAPACITY:**

Standard Duty -  
250lbs rating. More than enough drawer slide for 95% of applications.



Extreme Duty -  
500lbs rating. Just like the name says, these slides are designed for extreme conditions.



**NEW  
FEATURE  
COMING SOON....**

**DRAWER DIVIDER SYSTEM**

- Improved configurability
- Secure fitment of dividers
- Durable composite construction



**DRAWER ADD ONS:**

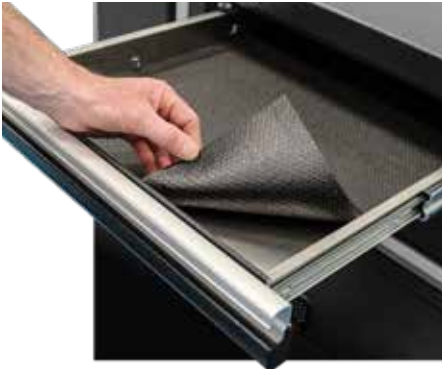

**DRAWER LINER**

- Heavy duty, high quality rubberized foam
- Keeps tools protected and safe

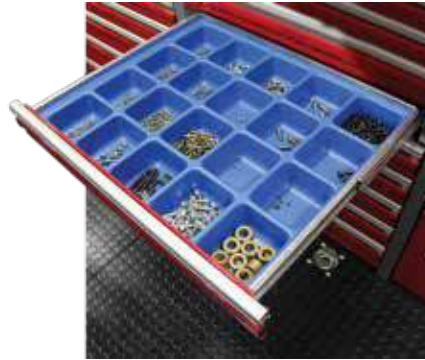

**MOLDED PARTS TRAY**

- Trim to fit
  - Leak proof
  - Easy to clean
  - Available in 3" & 4" drawers
- MSRP: \$27.50



**DIV - Front to Back**

- (4) adjustable (front to back) dividers (only available when order is placed, cannot be added later)
- MSRP: \$22.00



**DIV - Side to Side**

- (4) adjustable (side to side) dividers (can be added later as long as drawer is punched)
- MSRP: \$22.00



**DIV 2**

- (1) fixed (front to back) divider
  - (4) adjustable (side to side) dividers
- MSRP: \$37.40



**DIV 3**

- (2) fixed (front to back) divider
  - (6) adjustable (side to side) dividers
- MSRP: \$46.75

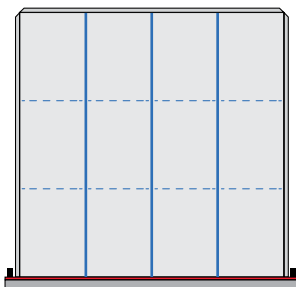

**DIV 4**

- (3) fixed (front to back) divider
  - (8) adjustable (side to side) dividers
- MSRP: \$57.50

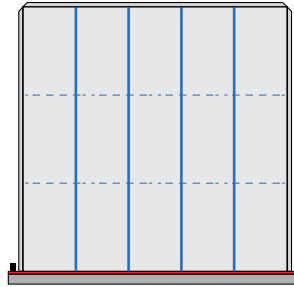

**DIV 5**

- (4) fixed (front to back) divider
  - (10) adjustable (side to side) dividers
- MSRP: \$68.75

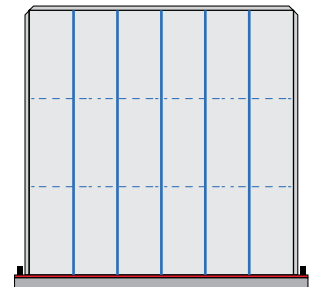

**DIV 6**

- (5) fixed (front to back) divider
  - (12) adjustable (side to side) dividers
- MSRP: \$79.75

Additional separators:

DIV 2-6: \$1.65 DIV (side to side, front to back): \$5.50

***DRAWER INSERT***



***INSERT STYLES*** NON-SERVICE BODY

**DRAWERS**



***DRAWER HOUSING***



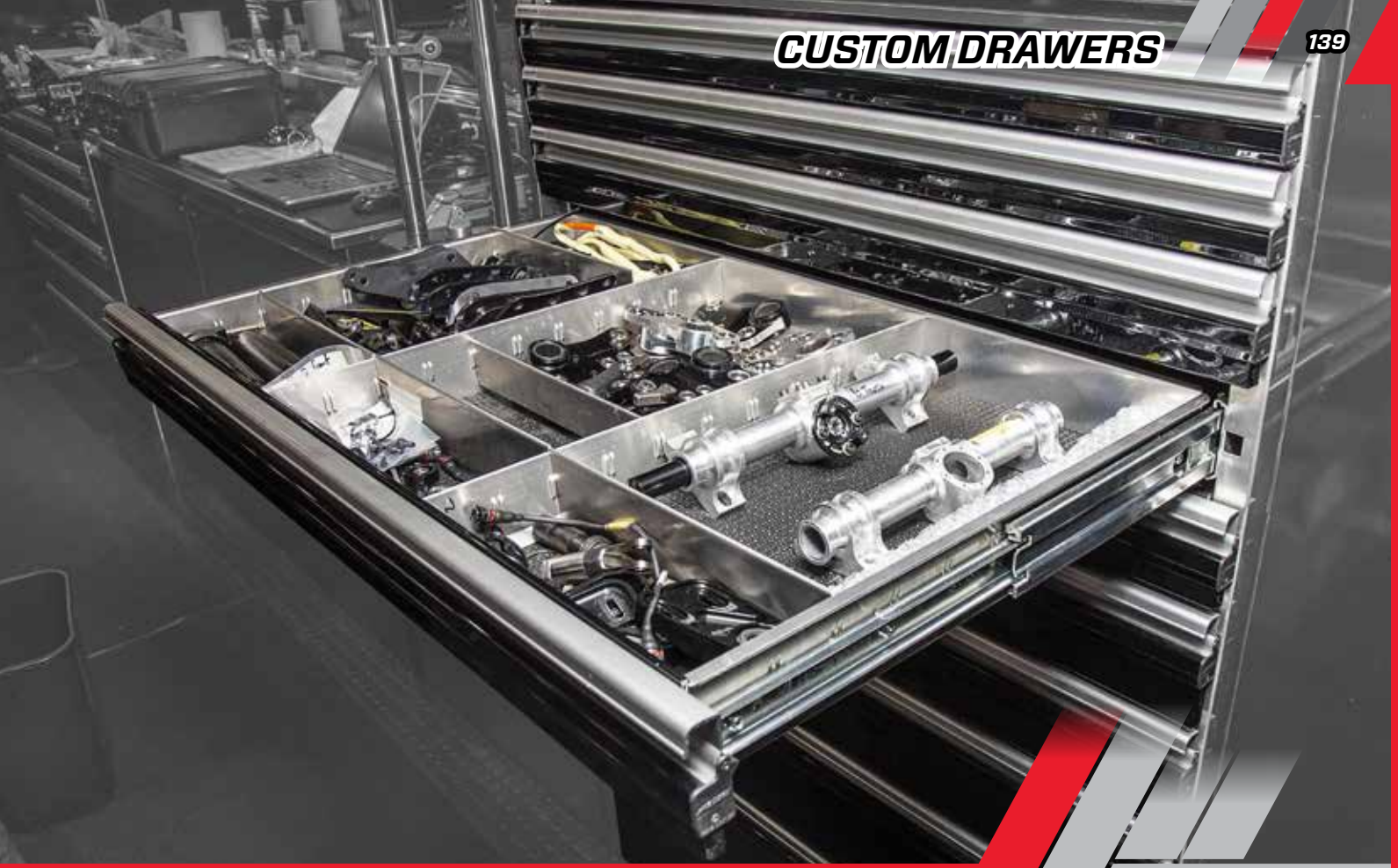





**DRAWERS**

***PREMIUM  
DRAWERS  
FOR THE  
WORKING  
PROFESSIONAL***









*"I've worked in some of the toughest, most remote places on earth; from Alaska, to the Yukon and the heights of the Rocky Mountains. I need equipment that can stand up to the rigors of my work environment and the rough demands of my everyday work. My CTech drawers have definitely answered that call. They are by far superior to any other drawers I've used in my service trucks. Not only are they stout and durable, my CTech drawers keep my tools organized, even after driving over the rocky terrain of remote work sites. I know I can count on my CTech drawers to stand up to anything I can put them through and continue to roll smoothly and keep my equipment safe and sound. I wouldn't trust my most valuable assets to any other drawer system."*

*-Juan Ibarra, owner/operator Ibarra Industries LLC,  
from Discovery Channel's GOLD RUSH*









# TACTICAL S



LAW ENFORCEMENT INSP



# SOLUTIONS



IRE - INDUSTRY PROVEN



# FEATURES

**Gear Guard (option)**  
- Gear guard helps secure equipment.



**Extruded Aluminum Frame**  
-lightweight aluminum cabinet frame is pound for pound stronger than most steel alloys.



**Inverted Top**  
- Designed for optimal storage capabilities, deep enough to secure equipment on top.



**Body Panels**  
- Tough powder coat aluminum double walled doors for strength and rigidity.  
.090" extrusions  
.080" body panels  
.080" drawer body



**MotionLatch™ Drawers**  
- ONE HAND - ONE MOTION opening function lets you grab anywhere on the extruded aluminum handle and effortlessly open our 250lb rated drawers.



**MotionLatch™ Lock**  
- Add security to your equipment with the patented lock system.



**QuickLink Mounting Plate \*** (see page 148)  
- The key feature to a transferable cabinet and quick installation of the CTech CopBox Cabinet.

**5052**  
ALUMINUM  
BODY PANELS

EXTRUDED  
ALUMINUM FRAME



**RADIUS  
CORNERS**  
FASTENER ASSEMBLED





Engineered with strong aluminum extrusions



Dual composite latches stay closed

## MOTIONLATCH™ DRAWERS & DOORS

- Offers a ONE HAND - ONE MOTION operation even with a handful of tools
- No pinching, no squeezing, no twisting, just pull the handle and the latches release
- MotionLatch™ opening function lets you grab anywhere on the extruded aluminum handle and effortlessly open our 250lb rated drawers

CTECH EXCLUSIVE

**MotionLatch™**

**Drawer & Door System**

US Patent 6,547,289

# FEATURES

1

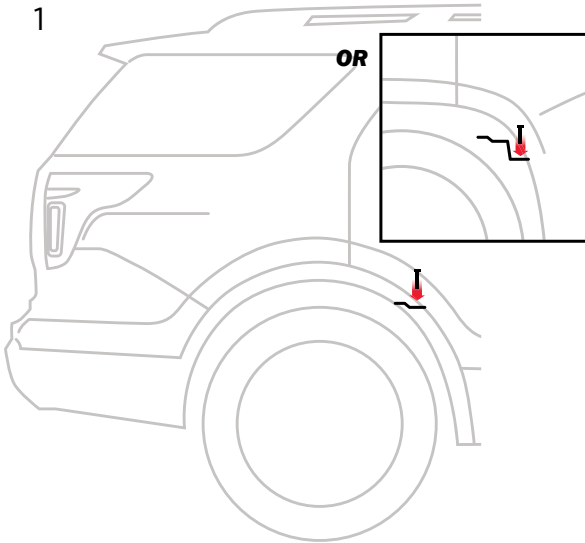

2

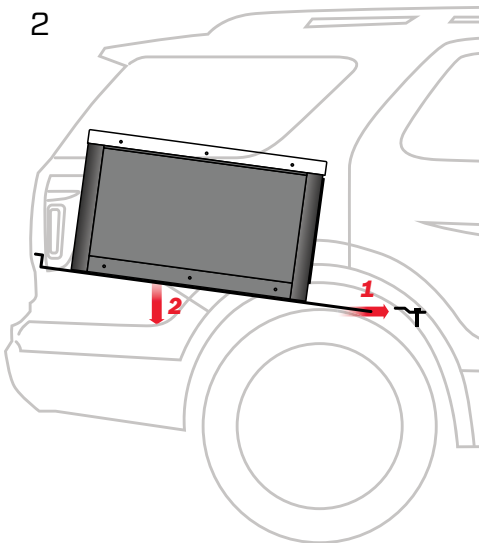

3

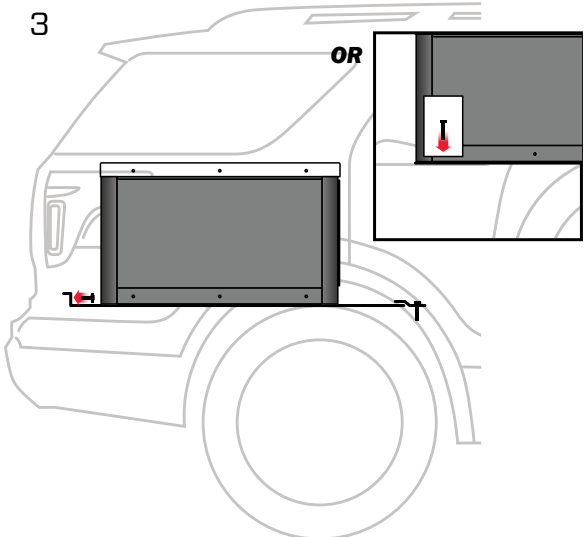

*Dodge Durango*

*Ford Interceptor Utility*

*Ford Explorer*

*Chevrolet Tahoe*

*Ford Expedition*

*Chevrolet Suburban - not shown*

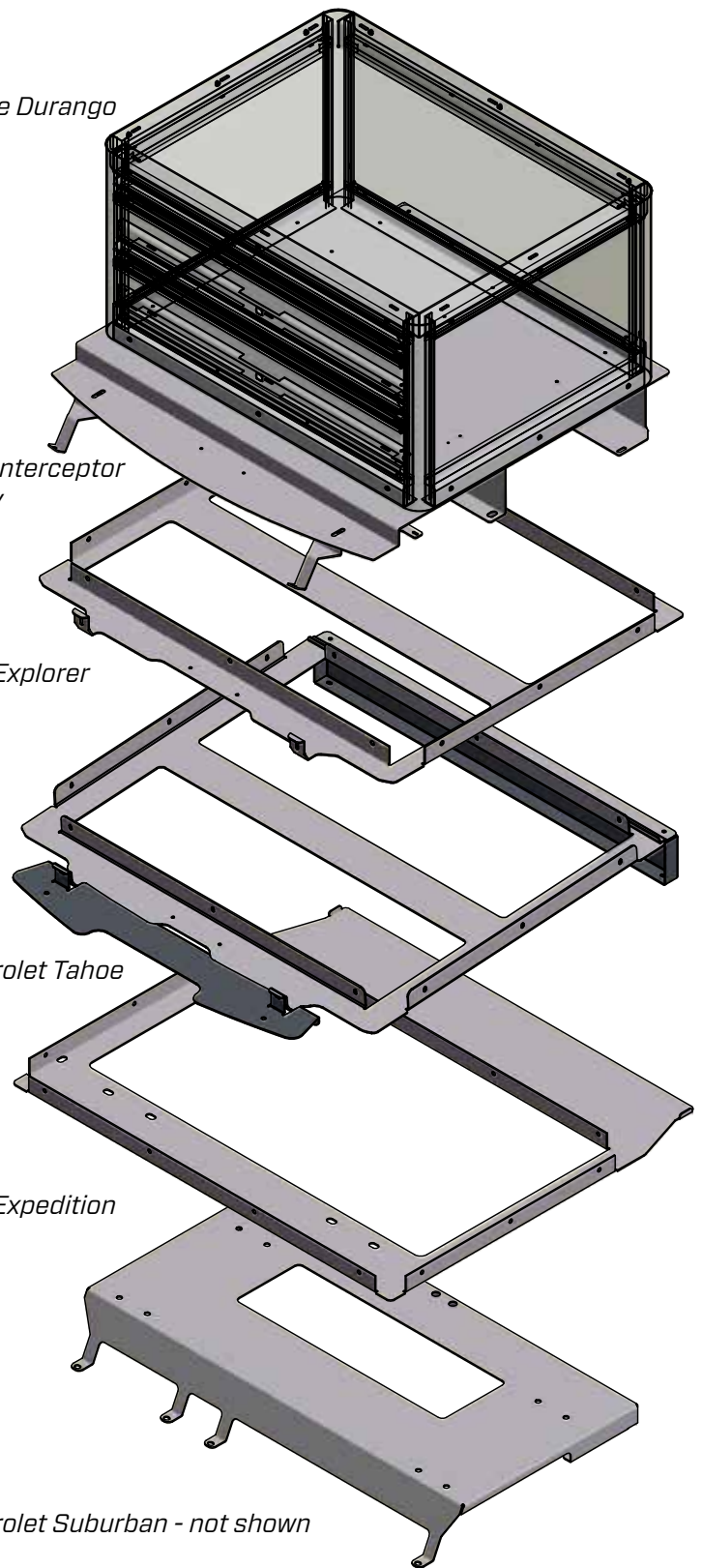

## **QUICKLINK MOUNTING SYSTEM**

- Allows universal mounting between vehicles
- FAST & EASY installation and removal
- Factory mounting locations
- No modifications to vehicle needed
- Switch vehicle manufacturers and just replace the QuickLink plate to fit the new vehicle
- **All 2020 pursuit vehicles are supported**





***NOW AVAILABLE: 2020 Ford Interceptor QuickLink mounts***  
***-Order new or retrofit to your existing CopBox from the previous generation Interceptors.***

TACTICAL



# COPBOX CABINETS



TACTICAL

## **COPBOX CABINET:**

-With increased utilization of SUVs as Police Pursuit Vehicles, focus on organization and safety is crucial. CTech's lightweight aluminum CopBox Cabinet is designed to ensure safety for the officers while increasing efficiency and value to the fleet.

**- SAFETY - SECURITY - EFFICIENCY - VALUE -**





<b>SPECIFICATIONS:</b>	<b>M40-301</b>
WIDTH	40
HEIGHT	12
DEPTH	30
SPARE TIRE ACCESS	YES
# OF DRAWERS	0
NET WEIGHT	61lbs
MSRP	\$495.00

**METRO SERIES - M40-301**

- Interior dimensions: 37W x 12H x 27D
- Lockable Flip Lid
- Gas shock stays
- QuickLink Mounting System
- Universal fitment, MID & Full size SUVs

<b>SPECIFICATIONS:</b>	<b>R40-301</b>
WIDTH	40
HEIGHT	12
DEPTH	30
SPARE TIRE ACCESS	YES
# OF DRAWERS	1
NET WEIGHT	73lbs
MSRP	\$995.00

**RESPONDER SERIES - R40-301**

- MotionLatch™ Drawer
- Interior dimensions: 31.625W x 6H x 25.5D (40.5 diagonal)
- QuickLink Mounting System
- Universal fitment, MID & Full size SUVs



<b>SPECIFICATIONS:</b>	<b>R47-301</b>
WIDTH	47
HEIGHT	12
DEPTH	30
SPARE TIRE ACCESS	NA
# OF DRAWERS	1
NET WEIGHT	80lbs
MSRP	\$1095.00

**RESPONDER SERIES - R47-301**

- MotionLatch™ Drawer
- Interior dimensions: 38.625W x 6H x 25.5D (44 diagonal)
- QuickLink Mounting System
- Full size SUVs



<b>SPECIFICATIONS:</b>	<b>P40-301</b>
<b>WIDTH</b>	<b>40</b>
<b>HEIGHT</b>	<b>16</b>
<b>DEPTH</b>	<b>30</b>
<b>SPARE TIRE ACCESS</b>	<b>YES</b>
<b># OF DRAWERS</b>	<b>1</b>
<b>NET WEIGHT</b>	<b>82lbs</b>
<b>MSRP</b>	<b>\$1095.00</b>

#### PATROL SERIES - P40-301

- MotionLatch™ Drawer
- Interior dimensions: 31.625W x 6H x 25.5D (40.5 diagonal)
- QuickLink Mounting System
- Universal fitment, MID & Full size SUVs



<b>SPECIFICATIONS:</b>	<b>P47-301</b>
<b>WIDTH</b>	<b>47</b>
<b>HEIGHT</b>	<b>16</b>
<b>DEPTH</b>	<b>30</b>
<b>SPARE TIRE ACCESS</b>	<b>NA</b>
<b># OF DRAWERS</b>	<b>1</b>
<b>NET WEIGHT</b>	<b>90lbs</b>
<b>MSRP</b>	<b>\$1195.00</b>

#### PATROL SERIES - P47-301

- MotionLatch™ Drawer
- Interior dimensions: 38.625W x 10H x 25.5D (44 diagonal)
- QuickLink Mounting System
- Full size SUVs



<b>SPECIFICATIONS:</b>	<b>T40-301</b>
<b>WIDTH</b>	<b>40</b>
<b>HEIGHT</b>	<b>20</b>
<b>DEPTH</b>	<b>30</b>
<b>SPARE TIRE ACCESS</b>	<b>NO</b>
<b># OF DRAWERS</b>	<b>1</b>
<b>NET WEIGHT</b>	<b>124lbs</b>
<b>MSRP</b>	<b>\$1195.00</b>

#### TACTICAL SERIES - T40-301

- MotionLatch™ Drawer
- Interior dimensions: 31.625W x 14H x 25.5D (40.5 diagonal)
- QuickLink Mounting System
- Universal fitment, MID & Full size SUVs







<b>SPECIFICATIONS:</b>	<b>T40-302</b>
<b>WIDTH</b>	<b>40</b>
<b>HEIGHT</b>	<b>20</b>
<b>DEPTH</b>	<b>30</b>
<b>SPARE TIRE ACCESS</b>	<b>NO</b>
<b># OF DRAWERS</b>	<b>2</b>
<b>NET WEIGHT</b>	<b>148lbs</b>
<b>MSRP</b>	<b>\$1495.00</b>

**TACTICAL SERIES - T40-302**

- MotionLatch™ Drawer
- Interior dimensions: #1 - 31.625W x 7H x 25.5D (40.5 diagonal), #2 - 31.625W x 7H x 25.5D (40.5 diagonal)
- QuickLink Mounting System
- Universal fitment, MID & Full size SUVs

<b>SPECIFICATIONS:</b>	<b>T47-301</b>
<b>WIDTH</b>	<b>47</b>
<b>HEIGHT</b>	<b>20</b>
<b>DEPTH</b>	<b>30</b>
<b>SPARE TIRE ACCESS</b>	<b>NA</b>
<b># OF DRAWERS</b>	<b>1</b>
<b>NET WEIGHT</b>	<b>132lbs</b>
<b>MSRP</b>	<b>\$1295.00</b>

**TACTICAL SERIES - T47-301**

- MotionLatch™ Drawer
- Interior dimensions: 38.625W x 14H x 25.5D (44 diagonal)
- QuickLink Mounting System
- Universal fitment, MID & Full size SUVs



<b>SPECIFICATIONS:</b>	<b>T47-302</b>
<b>WIDTH</b>	<b>47</b>
<b>HEIGHT</b>	<b>20</b>
<b>DEPTH</b>	<b>30</b>
<b>SPARE TIRE ACCESS</b>	<b>NA</b>
<b># OF DRAWERS</b>	<b>2</b>
<b>NET WEIGHT</b>	<b>164lbs</b>
<b>MSRP</b>	<b>\$1595.00</b>

**TACTICAL SERIES - T47-302**

- MotionLatch™ Drawer
- Interior dimensions: #1 - 38.625W x 7H x 25.5D (44 diagonal), #2 - 38.625W x 7H x 25.5D (44 diagonal)
- QuickLink Mounting System
- Universal fitment, MID & Full size SUVs



<b>SPECIFICATIONS:</b>	<b>C40-301</b>
<b>WIDTH</b>	<b>40</b>
<b>HEIGHT</b>	<b>26</b>
<b>DEPTH</b>	<b>30</b>
<b>SPARE TIRE ACCESS</b>	<b>NO</b>
<b># OF DRAWERS</b>	<b>2</b>
<b>NET WEIGHT</b>	<b>156lbs</b>
<b>MSRP</b>	<b>\$2295.00</b>

#### COMMAND SERIES - C40-301

- MotionLatch™ Drawer & Door
- Interior dimensions: #1 - 13.28W x 9H x 25.5D, #2 - 13.28W x 12H x 25.5D
- Adjust-a-loc shelving in opening
- QuickLink Mounting System
- Universal fitment, MID & Full size SUVs



<b>SPECIFICATIONS:</b>	<b>C40-302</b>
<b>WIDTH</b>	<b>40</b>
<b>HEIGHT</b>	<b>26</b>
<b>DEPTH</b>	<b>30</b>
<b>SPARE TIRE ACCESS</b>	<b>NO</b>
<b># OF DRAWERS</b>	<b>3</b>
<b>NET WEIGHT</b>	<b>168lbs</b>
<b>MSRP</b>	<b>\$2395.00</b>

#### COMMAND SERIES - C40-302

- MotionLatch™ Drawer & Door
- Interior dimensions: #1 - 13.28W x 5H x 25.5D, #2 - 13.28W x 12H x 25.5D, #3 - 13.28W x 4H x 25.5D
- Adjust-a-loc shelving in opening
- Flip up white-board
- QuickLink Mounting System
- Universal fitment, MID & Full size SUVs

<b>SPECIFICATIONS:</b>	<b>C47-301</b>
<b>WIDTH</b>	<b>47</b>
<b>HEIGHT</b>	<b>26</b>
<b>DEPTH</b>	<b>30</b>
<b>SPARE TIRE ACCESS</b>	<b>NA</b>
<b># OF DRAWERS</b>	<b>2</b>
<b>NET WEIGHT</b>	<b>166lbs</b>
<b>MSRP</b>	<b>\$2495.00</b>

#### COMMAND SERIES - C47-301

- MotionLatch™ Drawer & Door
- Interior dimensions: #1 - 13.28W x 9H x 25.5D, #2 - 13.28W x 12H x 25.5D
- Adjust-a-loc shelving in opening
- QuickLink Mounting System
- MID & Full size SUVs







<b>SPECIFICATIONS:</b>	<b>C47-302</b>
WIDTH	47
HEIGHT	26
DEPTH	30
SPARE TIRE ACCESS	NA
# OF DRAWERS	3
NET WEIGHT	180lbs
MSRP	\$2595.00

**COMMAND SERIES - C47-302**

- MotionLatch™ Drawer & Door
- Interior dimensions: #1 - 13.28W x 5H x 25.5D, #2 - 13.28W x 12H x 25.5D, #3 - 13.28W x 4H x 25.5D
- Adjust-a-loc shelving in opening
- Flip up white-board
- QuickLink Mounting System
- Full size SUVs

<b>SPECIFICATIONS:</b>	<b>PS40-302</b>
WIDTH	40
HEIGHT	16
DEPTH	30
SPARE TIRE ACCESS	YES
# OF DRAWERS	1
NET WEIGHT	62lbs
MSRP	\$1095.00



**PATROL SCALE SERIES - PS40-302**

- MotionLatch™ Drawer and Door
- Interior dimensions: 38.625W x 3H x 25.5D (44 diagonal)
- HAENNI Scale mounts (up to 6 scales)
- QuickLink Mounting System
- Universal fitment, MID & Full size SUVs



<b>SPECIFICATIONS:</b>	<b>CS40-301</b>
WIDTH	40
HEIGHT	26
DEPTH	30
SPARE TIRE ACCESS	NO
# OF DRAWERS	1
NET WEIGHT	164lbs
MSRP	\$1495.00

**COMMAND SCALE SERIES - CS40-301**

- MotionLatch™ Drawer
- Interior dimensions: 38.625W x 12H x 25.5D (44 diagonal)
- HAENNI Scale mounts (up to 6 scales)
- QuickLink Mounting System
- Universal fitment, MID & Full size SUVs

<b>SPECIFICATIONS:</b>	<b>C45-401</b>
WIDTH	45
HEIGHT	26
DEPTH	40
SPARE TIRE ACCESS	NA
# OF DRAWERS	3
NET WEIGHT	226lbs
MSRP	\$2895.00



- COMMANDER SERIES - C45-401**
- MotionLatch™ Drawer and Door
  - Interior dimensions: #1 - 17.5W x 8H x 35.5D, #2 - 17.5W x 13H x 35.5D, #3 - 13W x 6H x 35.5D
  - HAENNI Scale storage behind door (up to 4 scales)
  - QuickLink Mounting System
  - Gear Guard (standard)
  - Full size SUVs

<b>SPECIFICATIONS:</b>	<b>F47-351</b>
WIDTH	47
HEIGHT	26
DEPTH	35
SPARE TIRE ACCESS	NA
# OF DRAWERS	4
NET WEIGHT	215lbs
MSRP	\$ CALL



**FIRE SERIES - F47-351**

- MotionLatch™ Drawer
- MotionLatch™ accessory rack
- Interior dimensions: NA
- Flip up dry erase board
- QuickLink Mounting System
- Full size SUVs

**POWDER COAT COLORS:**



\* ANY STANDARD PRODUCT CAN BE CUSTOMIZED TO YOUR SPECIFIC NEEDS, PLEASE CALL 715-355-8842 AND TALK TO YOUR CTECH REPRESENTATIVE TODAY. \*







# TROOPER SERIES

*Only available for  
Ford Interceptors*



TACTICAL

## **TROOPER SERIES:**

-With increased utilization of SUVs as Police Pursuit Vehicles, focus on organization and safety is crucial. CTech's lightweight aluminum Trooper Series is designed to ensure safety for the officers. Gathering design and layout criteria from State Patrol departments throughout the U.S., we have developed the most efficient and safe product available.

**- SAFETY - SECURITY - EFFICIENCY - VALUE -**



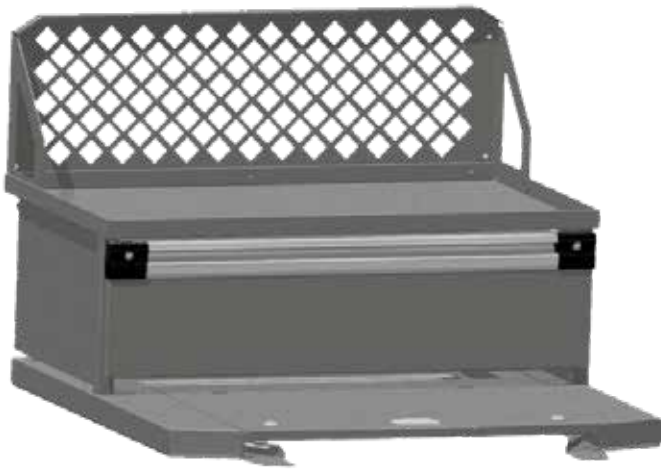

<b>SPECIFICATIONS:</b>	<b>TDUI-402</b>
WIDTH	40
HEIGHT	13.625
DEPTH	24
SPARE TIRE ACCESS	YES
# OF DRAWERS	1
NET WEIGHT	NA
MSRP	\$1195.00

## TROOPER SERIES - TDU-SINGLE

- MotionLatch™ Drawer
- Locking Drawer
- Spare Tire Access Door
- Set Back Design
- Gear Guard

<b>SPECIFICATIONS:</b>	<b>TDUI40-401</b>
WIDTH	40
HEIGHT	21.625
DEPTH	24
SPARE TIRE ACCESS	YES
# OF DRAWERS	2
NET WEIGHT	NA
MSRP	\$1495.00

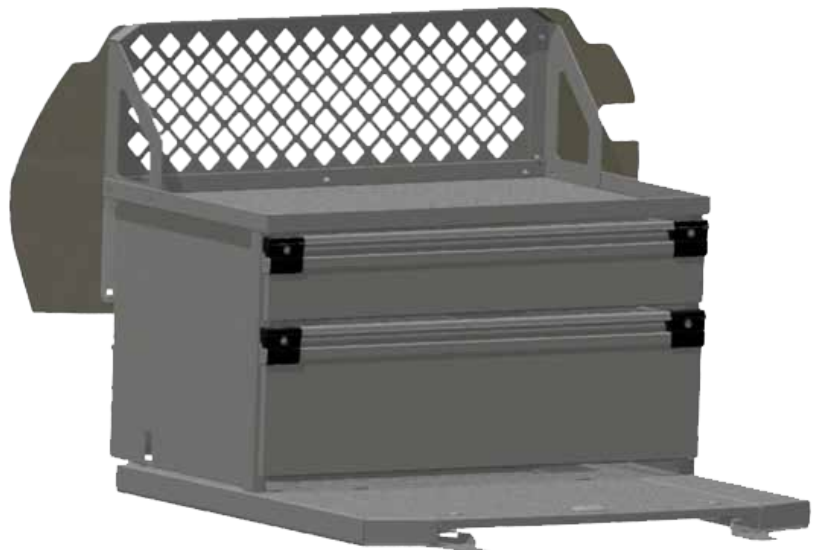

## TROOPER SERIES - TDUI40-401

- MotionLatch™ Drawer
- Locking Drawers
- Spare Tire Access Door
- Set Back Design
- Gear Guard
- Vented Electronics Drawer



<b>SPECIFICATIONS:</b>	<b>TDU40-401</b>
WIDTH	40
HEIGHT	21.5
DEPTH	40.5
SPARE TIRE ACCESS	YES
# OF DRAWERS	2
NET WEIGHT	NA
MSRP	\$1695.00

## TROOPER SERIES - TDU40-401

- MotionLatch™ Drawer
- Locking Drawers and Door
- Gun Storage
- Spare Tire Access Door
- Set Back Design
- Gear Guard
- Vented Electronics Drawer

# COPBOX OPTIONS

\* ANY STANDARD PRODUCT CAN BE CUSTOMIZED TO YOUR SPECIFIC NEEDS, PLEASE CALL 715-355-8842 AND TALK TO YOUR CTECH REPRESENTATIVE TODAY. \*

## CARGO DIVIDER:



COMMAND SERIES: optional



TACTICAL SERIES: optional

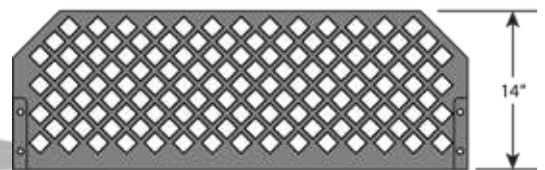

PATROL SERIES: optional

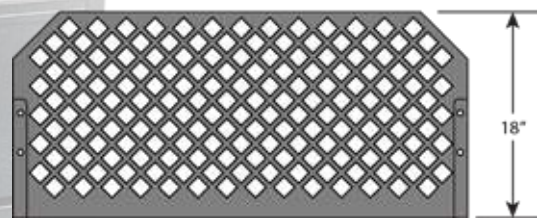

RESPONDER SERIES: NA  
METRO SERIES: NA

Added security for gear stored on the top of the CopBox Cabinet - \$218.90

## ELECTRONICS STORAGE:



Easily accessible organized storage for electronics - \$218.90



## LIFT ASSIST: 2011-2019 Ford Interceptors only



Enables easy access to the spare tire on applicable models - \$218.90 \*Metro Series only (Standard on Patrol and Responder Series)

## UNIVERSAL FLOOR MOUNT:



Standard equipment (QuickLink Mounting plate) is removed and replaced with a standard floor. This allows universal mounting to any flat surface.

# MODEL COMPARISON

## Trooper Series

Only available for Ford Interceptors

## CopBox Series



SERIES	TROOPER	TROOPER	TROOPER	METRO	RESPONDER	PATROL
MODEL #	TDUI-402	TDUI40-401	TDU40-401	M40-301	R40-301 R47-301	P40-301 P47-301
DIMENSIONS (inches)	40W x 13.625H x 24D	40W x 21.625H x 24D	40W x 21.5H x 40.5D	40W x 12H x 30D	40W x 12H x 30D 47W x 12H x 30D	40W x 16H x 30D 47W x 16H x 30D
WIDE BODY	NO	NO	NO	NO	YES R47-301	YES P47-301
GEAR GUARD	YES	YES	YES	NO	NO	YES - 18"
ELECTRONIC COVER	NO	Drawer Style	Drawer Style	NO	NO	YES
SPARE TIRE	YES	YES	YES	YES	YES	YES
VEHICLE SIZE	40" wide - MID-SIZE	40" wide - MID-SIZE	40" wide - MID-SIZE	40" wide - MID-SIZE 47" wide - FULL-SIZE	40" wide - MID-SIZE 47" wide - FULL-SIZE	40" wide - MID-SIZE 47" wide - FULL-SIZE
FEATURES	Powder Coat, Liner, Spare Tire Access Door, Locking Drawers	Powder Coat, Liner, Spare Tire Access Door, Plexi Side Dividers, Locking Drawers	Powder Coat, Liner, Spare Tire Access Door, Gun Storage, Locking Drawers	Powder Coat, Liner, QuickLink Mounting, Locking Flip Lid	Powder Coat, Liner, Dividers, Locking, QuickLink Mounting	Powder Coat, Liner, Dividers, Locking, QuickLink Mounting
# OF DRAWERS	1	2	2	0	1	1
# OF DOORS	0	0	1	0	0	0
WEIGHT	NA lbs	NA lbs	NA lbs	61 lbs	73 lbs	82 lbs
MSRP \$	MID SIZE \$1195.00	MID SIZE \$1495.00	MID SIZE \$1695.00	MID-FULL SIZE \$495.00	MID-SIZE \$995.00 FULL-SIZE \$1095.00	MID-SIZE \$1095.00 FULL-SIZE \$1195.00

For large fleet orders, please contact CTech for pricing.





TACTICAL	TACTICAL	COMMAND	COMMAND	PATROL SCALE	COMMAND SCALE	COMMANDER *
T40-301 T47-301	T40-302 T47-302	C40-301 C47-301	C40-302 C47-302	PS40-302	CS40-301	C45-401
40W x 20H x 30D 47W x 20H x 30D	40W x 20H x 30D 47W x 20H x 30D	40W x 26H x 30D 47W x 26H x 30D	40W x 26H x 30D 47W x 26H x 30D	40W x 16H x 30D	40W x 26H x 30D	45W x 26H x 40D
YES T47-301	YES T47-302	YES C47-301	YES C47-302	NO	NO	ONLY WIDE
YES - 14"	YES - 14"	YES - 10"	YES - 10"	YES - 18"	YES - 10"	YES - 10"
YES	YES	YES	YES	YES	YES	YES
NO	NO	NO	NO	YES	NO	NO
40" wide - MID-SIZE 47" wide - FULL-SIZE	40" wide - MID-SIZE 47" wide - FULL-SIZE	40" wide - MID-SIZE 47" wide - FULL-SIZE	40" wide - MID-SIZE 47" wide - FULL-SIZE	MID to FULL-SIZE	MID to FULL-SIZE	FULL-SIZE
Powder Coat, Liner, Dividers, Locking, QuickLink Mounting	Powder Coat, Liner, Dividers, Locking, QuickLink Mounting	Powder Coat, Liner, Dividers, Locking, QuickLink Mounting	Powder Coat, Liner, Dividers, Locking, Flip-Up White-board, QuickLink Mounting	Powder Coat, Liner, Dividers, Locking, HAENNI Scale Storage QuickLink Mounting	Powder Coat, Liner, Dividers, Locking, HAENNI Scale Storage QuickLink Mounting	Powder Coat, Liner, Dividers, Locking, HAENNI Scale Storage QuickLink Mounting
1	2	2	3	1	1	3 (1 electronic, 1 long gun)
0	0	1 (1 shelf)	1 (1 shelf)	2	0	1 (4 scale slots)
124 lbs	148 lbs	156 lbs	168 lbs	62 lbs	132lbs	226lbs
MID-SIZE \$1195.00 FULL-SIZE \$1295.00	MID-SIZE \$1495.00 FULL-SIZE \$1595.00	MID-SIZE \$2295.00 FULL-SIZE \$2495.00	MID-SIZE \$2395.00 FULL-SIZE \$2595.00	MID-FULL SIZE \$1095.00	MID-FULL SIZE \$1495.00	FULL SIZE \$2895.00*

(\* ) Indicates CopBox units available for State Contract or other Qualified Purchases at SPECIAL Pricing. Please contact your representative for details.

*Removable truck bed cabinet. This cabinet was designed on fork lift tubes for easy removal for bed use. It has 4 built in D-Rings to strap it into place when installed.*



## **CUSTOM TACTICAL**



*Easy access to scales in the rear of this police truck, while still having the ability to store gear in the bed.*





*A low profile design to fit under any cap and bed slides to allow for secure storage of gear. This cabinet also features Mac's Tie-Down buttons for additional storage strapping to top.*

*Full extension truck bed drawers available, designed to fit under a truck cap or tonneau cover.*



## CUSTOM TACTICAL SOLUTIONS

*With several thousand CopBox Cabinets in active duty across the United States CTech is proud to support the men and women on duty.*



## CUSTOM TACTICAL



*This Jeep Cabinet is designed to fit both 2 door and 4 door applications. The 1 drawer configuration offers secure storage with additional storage on top.*





*Revisions to our standard models throughout the CopBox inception has led to custom options such as flip lids and deep top compartments for secure, yet quick access.*

*The CopBox can be mounted into almost any application, but CTech has developed a few specific QuickLink platforms for the most common applications.*







Motor Vehicle Commission Mobile Office



# CUSTOM TACTICAL



Sheriff Mobile Command







*Police Incident Command*

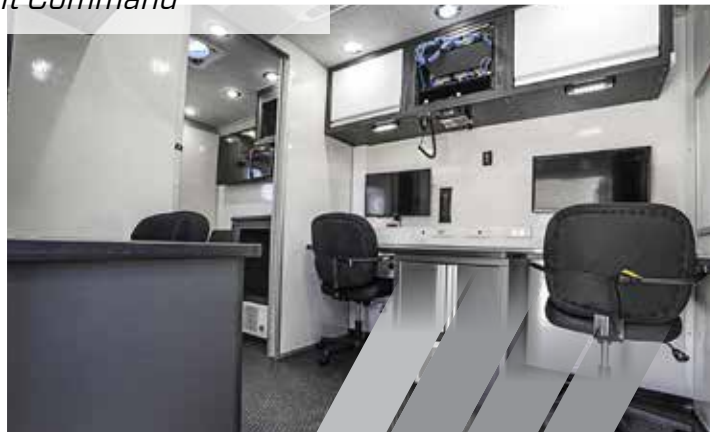

*Homeland Security and Emergency Management Mobile Office*













# *BLACKLINE*

EFFICIENCY AND ORGANIZATION OPTIONS





# *ACCESSORIES*





SPECIFICATIONS:	BL-ACC-10
<b>DIMENSIONS</b>	4.25"W x 8.5"D
<b>MSRP</b>	\$25.00

BLACKLINE - BL-ACC-10  
*Rag In A Box Holder*

- Securely holds "Rags in a box"
- Rag box is not included
- May fit other rag boxes as well



SPECIFICATIONS:	BL-ACC-11
<b>DIMENSIONS</b>	12"W x 17"D
<b>MSRP</b>	\$100.00

BLACKLINE - BL-ACC-11  
*Water Jug Rack*

- Holds 1-3 gallon jugs
- Jug not included



SPECIFICATIONS:	BL-ACC-5
<b>DIMENSIONS</b>	13.625"W x 7.1875"D
<b>MSRP</b>	\$85.00

BLACKLINE - BL-ACC-5  
*Paper Towel Dispenser*

- Prevents paper towel from unrolling
- easy paper change



SPECIFICATIONS:	BL-ACC-9
<b>DIMENSIONS</b>	36"W x 14"H
<b>MSRP</b>	\$190.00

BLACKLINE - BL-ACC-9  
*Fuel Jug Rack*

- Holds 3-5 gallon fuel jugs
- add a second mount kit to move mount from trailer to pit area

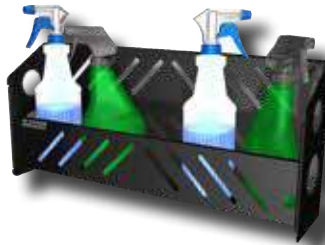

SPECIFICATIONS:	BL-ACC-2
<b>DIMENSIONS</b>	25.5"W x 10"H
<b>MSRP</b>	\$65.00

BLACKLINE - BL-ACC-2  
*Bottle Rack*

- Organize your bottles and cans



SPECIFICATIONS:	BL-ACC-8
<b>DIMENSIONS</b>	25.5"W x 10"H
<b>MSRP</b>	\$65.00

BLACKLINE - BL-ACC-8  
*Aerosol Can Rack*

- Holds up to 7 aerosol cans firmly in place



SPECIFICATIONS:	BL-ACC-7
<b>DIMENSIONS</b>	49.25"W x 20.165"H - OPEN 49.25"W x 6" - CLOSED
<b>MSRP</b>	\$430.00

BLACKLINE - BL-ACC-7  
*Flip-Down Bench*

- Quick fold away work surface
- add a second mount kit to move from the interior to the exterior of your trailer



SPECIFICATIONS:	BL-ACC-3
<b>DIMENSIONS</b>	49.25"W x 24.75"H - OPEN 49.25"W x 9" - CLOSED
<b>MSRP</b>	\$600.00

BLACKLINE - BL-ACC-3  
*Fold-Up Bench - Heavy Duty*

- Heavy duty additional work surface
- Stainless Steel top
- Bottle rack storage





SPECIFICATIONS:	BL-ACC-6
<b>DIMENSIONS</b>	20"W x 26.75"H
<b>MSRP</b>	\$465.00

BLACKLINE - BL-ACC-6  
*Charging / Radio Station*

- 2 accessory shelves
- 7-110v duplex receptacles



SPECIFICATIONS:	BL-ACC-12
<b>DIMENSIONS</b>	25.5"W x 24"H
<b>MSRP</b>	\$600.00

BLACKLINE - BL-ACC-12  
*Hanging MotionLatch™ Drawer Cabinet*

- Hemmed shelf work station
- 1-2", 2-4" MotionLatch™ Drawers



SPECIFICATIONS:	BL-ACC-4
<b>DIMENSIONS</b>	25.5"W x 50.5"H
<b>MSRP</b>	\$325.00

BLACKLINE - BL-ACC-4  
*Accessory Rack*

- 2- Bottle/Can racks
- 1- Aerosol Can rack
- 1- Paper towel dispenser



SPECIFICATIONS:	BL-ACC-1
<b>DIMENSIONS</b>	25.5"W x 46"H
<b>MSRP</b>	\$760.00

BLACKLINE - BL-ACC-1  
*Drawer Cabinet w/Accessory Rack*

- 1- Bottle/Can racks
- 1- Aerosol Can rack
- Hemmed shelf work station
- 1-2", 2-4" MotionLatch™ Drawers



SPECIFICATIONS:	BL-ACC-MOUNTKIT
<b>DIMENSIONS</b>	NA
<b>MSRP</b>	\$20.00

- BLACKLINE - BL-ACC-MOUNTKIT
- Molded from non-marring composite material
  - 4 QuickMounts per kit
  - Perfect addition to any existing accessory for added mount locations.

# WE BUILD

## **CARTS**

- RACE
- INDUSTRIAL
- CUSTOM

## **CABINETS**

- GARAGE
- SHOP
- TRAILER

ACCESSORIES



# IT BETTER

- HOUSING INSERT
- CABINET INSERT
- TOOL DRAWER INSERT

## DRAWERS

## TACTICAL

- LAW ENFORCEMENT
- FIRE/EMT
- MILITARY



ACCESSORIES

For more information on our capabilities check us out at [WWW.CTECHMANUFACTURING.COM](http://WWW.CTECHMANUFACTURING.COM)

## ***CTech Manufacturing Policies and Procedures***

**Terms** - *Standard terms for approved accounts are Net 30-days. Non-compliance to the terms may result in a late fee of up to 2% per month.*

**Cancellation and Change Policy** - *Orders canceled more than 24 hours from time of receipt are subject to a cancellation fee of up to 20%. Cancellation or changes must come in writing (not verbal) and be confirmed within 24 hours of the original purchase order being issues to avoid and potential change or cancellation fees.*

**Return Policy** - *Custom built products are non-returnable. Standard products are subject to a return fee of up to 20% plus the cost of freight to return the product. Products must have been purchased within the past 12 months. All returned products must be in like new, sale-able condition. Any returned products **MUST** have a Return Goods Authorization approved before returning. Any returns without a pre-approved RGA will be rejected and returned to sender.*

**Warranty Policy** - *CTech Manufacturing offers a limited lifetime warranty\* against any manufacturing defects in material or workmanship so long as the original purchaser retains ownership, possession, and control of the product.*

\* **Note** - *Slides are a purchased product and are warranted for one year from date of original invoice. Slides are passed through to the original manufacturer for inspection and processing.*



# 50%

## **WEIGHT SAVINGS**

on average over a steel comparison

**IN HOUSE**

ALL ALUMINUM

POWDER  
COAT  
FINISH

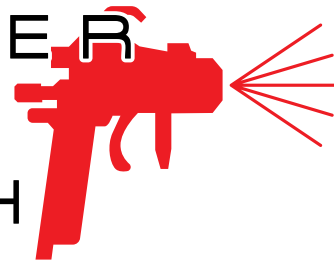

*Taking industry standards and*  
***BUILDING IT BETTER***  
***for 25 YEARS!***



CTech Manufacturing is a Wisconsin based company dedicated to customer satisfaction, quality products and industry leading innovations.

***With 25 years of experience, CTech has established itself as the most respected name in manufactured aluminum carts, cabinets and drawers for mobile applications. Our customer relationships help drive our business in new directions and keep CTech the leader of pack.***

# WWW.CTECHMANUFACTURING.COM



CTECH Manufacturing  
7501 Commerce Dr  
Weston, WI 54476  
(p) 715-355-8842  
(f) 715-355-8932

© All Rights Reserved 2019 CTECH Manufacturing - 112019

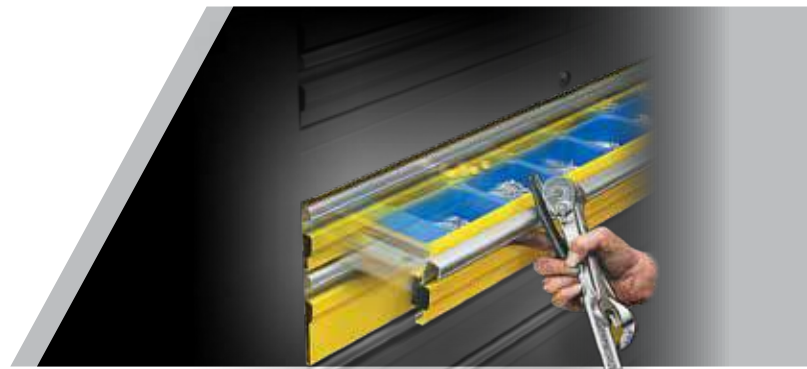

CTECH EXCLUSIVE  
**MotionLatch™**  
**Drawer & Door System**  
US Patent 6,547,289

*The one and only MotionLatch!*  
Only available from CTEch, don't be fooled by imitators